

IXG System

IP network-compatible intercom

IXG Support Tool Setting Manual: Property Manager Mode

Software version: 3.0.0.0 or later

Important

- Before configuring and using the system, read Setting Manual (this document) and Operation Manual carefully.
- For the installation and connection of each device, refer to "Installation Manual."
- Begin installation after reading and understanding the procedures for system configuration.
- The setting file is required for post-installation maintenance and service. Write the setting file to a CD-R or other media and be sure to give it to the customer.
- The illustrations and images in this manual may vary from the actual ones.
- Configure each function according to regulations, laws, and policies related to personal information in the applicable country and municipality.

Table of contents

Introduction

1. Notational symbols in this manual	5
2. Device type	6
3. Product manuals	7
4. Station description	8
4.1 Tenant Station (IXG-2C7(-*))	8
4.2 Master Station (IX-MV7-*)	9
4.3 Guard Station (IXG-MK)	11
4.4 Handset Sub Station (IX-RS-*)	13
4.5 Entrance Station (IXG-DM7(-*))	15
4.6 Video Door Station (IX-EA, IX-EAU)/Door Station (IX-FA)	16
4.7 Video Door Station (IX-DA)/Door Stations (IX-BA)	18
4.8 Video Door Station (IX-DV, IX-DVF(-*)) /Door Stations (IX-SSA(-*))	20
4.9 Door Stations (IX-SS-2G)	25
4.10 Lift Control Adaptor (IXGW-LC)	26
4.11 Gateway Adaptor (IXGW-GW)	28
5. Configuring the system	30
6. Flowcharts for configuring the system	31
7. Flowcharts for Mobile App Integration	32
7.1 Registering the Mobile App	32
7.2 Adding a Mobile App to Each Unit	34
7.3 When the type of mobile device registered to a Residential unit was replaced	35
7.4 When the type of mobile device registered to a Guard or a Commercial unit was replaced	37

Startup and Configuration

1. System requirements	39
2. Installing IXG Support Tool	40
3. Login and registration of the station	41
4. How to Configure	42
4.1 Settings window	42
4.2 How to Configure	43
5. System settings list	45

Menu bar

1. File	48
1.1 Select Existing System	48
1.2 Delete Existing System	49
1.3 Exporting the IXG Support Tool System Configuration	50
1.4 Outputting IXG Supervision Tool Data	51
1.5 IXG Support Tool Settings	52
1.6 Exit	55
2. Connection	56

2.1 Station Search	56
2.2 Download Settings	57
2.3 Upload Settings	59
2.4 Download Log File	62
3. App Integration	63
3.1 Upload Settings to IXG Cloud Server	64
3.2 Applying QR Code for App Registration to a station	67
3.3 Export QR Code for App Registration	68
3.4 Site List	69
3.5 Property manager Account Settings	70
3.6 Manual IXG Cloud Server and Gateway Sync	73
4. View	74
5. Language	75
6. Help	76
6.1 About	76

System Settings

1. Site Information (Move-in Settings)	78
1.1 Units / Stations	78
2. Station Information (Move-in Settings)	81
2.1 Identification	81
3. System Information (Move-in Settings)	83
3.1 Station List	83
3.2 Mobile App List	86
3.3 Network Camera List	88
3.4 Group	92
4. Call Settings (Move-in Settings)	95
4.1 Called Stations (Door/Sub Stations)	95
4.2 Guard Button	99
5. Move-out Settings (Move-out Settings)	100
5.1 Resident Move-out	100
5.2 Delete Unit Information	101
6. Entrance Station Settings (Misc.)	102
6.1 Access Code	102
6.2 Welcome Screen	106
7. Transfer Settings (Misc.)	108
7.1 Absent Transfer	108
7.2 Delay Transfer	110
7.3 Schedule Transfer	112

Additional Settings

1. Confirming Station Information	120
1.1 Confirming Station Information on the Entrance Station	120
1.2 Confirming property manager ID and password on the Tenant Station	122





Introduction

This manual describes IXG Support Tool in detail.

The IXG System offers a separate manual for Installation, Settings, and Operations. Refer to the relevant manual.

1. Notational symbols in this manual

The following symbols identify important information concerning operational procedures.

	Indicates that users may require caution (including warning / caution).
	Alerts users to prohibited actions.
	Restricts user actions / provides instructions.
	Tips and additional information for operation.

- Terms displayed on master station and PC screens are indicated as **[XXXX]**.
- Page reference are shown as "[Title \(→ page XX\)](#)," [\(→ page XX\)](#), or [page XX](#).

2. Device type

The stations are shown as below.

	Device Type	Example Model Name
Tenant Stations	IXG-2C7(-*)	IXG-2C7, IXG-2C7-L
Master Stations	IX-MV7-*	IX-MV7-HW, IX-MV7-W, IX-MV7-HB, IX-MV7-B
Guard Stations	IXG-MK	IXG-MK
Handset Sub Station	IX-RS-*	IX-RS-W, IX-RS-B
Video Entrance Stations	IXG-DM7(-*)	IXG-DM7, IXG-DM7-HID
Video Stations	IX-DV, IX-DVF(-*)	IX-DV, IX-DVF, IX-DVF-P, IX-DVF-L, IX-DVF-2RA, IX-DVF-RA
	IX-DA	IX-DA
	IX-EA, IX-EAU	IX-EA, IX-EAU※1
Audio Stations	IX-SSA(-*)	IX-SSA, IX-SSA-2RA, IX-SSA-RA
	IX-SS-2G	IX-SS-2G
	IX-BA	IX-BA
	IX-FA	IX-FA※1
Lift Control Adaptor	IXGW-LC	IXGW-LC
Gateway Adaptor	IXGW-GW	IXGW-GW
Intercom Application (AIPHONE IXG)	Intercom App	ASP-IXGI, ASP-IXGA

※ 1 Japan only

3. Product manuals

Read the "Installation Manual," "Setting Manual," and "Operation Manual" as needed. Have the person who installs or configures the product refer to the relevant manuals.

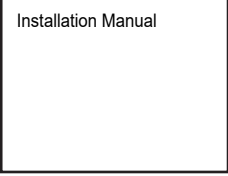
 <p>Installation Manual</p>	<p>Installation Manual (comes with each station.) Refer to when installing and connecting each station. (For installers)</p>
<p>The manuals listed to the right can be found on our Web site at "https://www.aiphone.net/product/support/" for download and reference. Download and refer to these manuals as necessary.</p>	<p>IXG Support Tool Setting Manual (Electronic format (PDF file/Web browser version).) Describes how to configure and maintain the system using IXG Support Tool. (For system administrator)</p>
	<p>Monitoring Software (IXG Supervision Tool) Operation Manual (Electronic format (PDF file/Web browser version).) Describes how to use the IXG Supervision Tool. (For system administrator)</p>
	<p>Operation Manual (Electronic format (PDF file/Web browser version).) Describes how to use each station. (For user)</p>
	<p>Installation Manual (Electronic format (PDF file).) Describes how to install each station. (For installers)</p>

4. Station description

4.1 Tenant Station (IXG-2C7(-*))

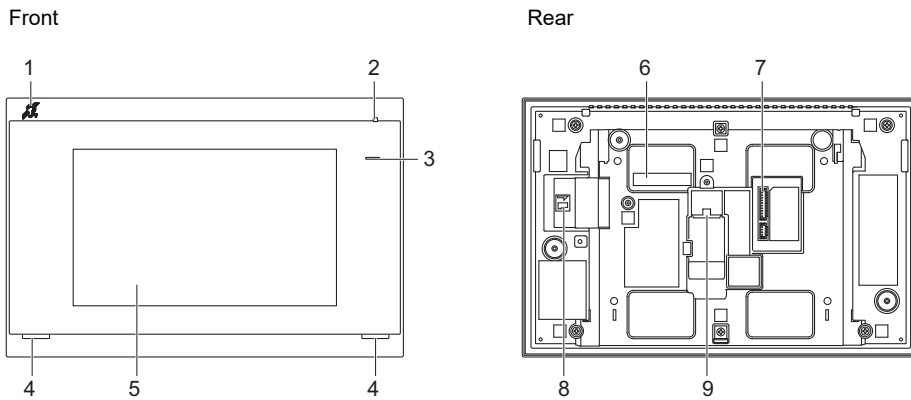

■ Part names



1	Hearing aid T-mode compatibility symbol (IXG-2C7-L only)	6	MAC address
2	Microphone	7	Option connector terminal
3	Status indicator (Blue)	8	microSD card slot
4	Speaker	9	LAN (PoE) port
5	Touchscreen LCD		

■ Indicators

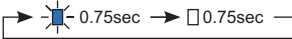
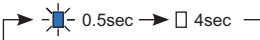
☀: ON, □: OFF

Name	Status (pattern)	Description
Status indicator	Blue flashing 	Booting
		Communication failure
		Firmware version updating
	Blue light 	Operating normally (may not light up when in standby depending on setting)

💡 Note

- For a status other than those noted here, refer to "Operation Manual."
- The display language is English by default.

4.2 Master Station (IX-MV7-*)

■ Part names

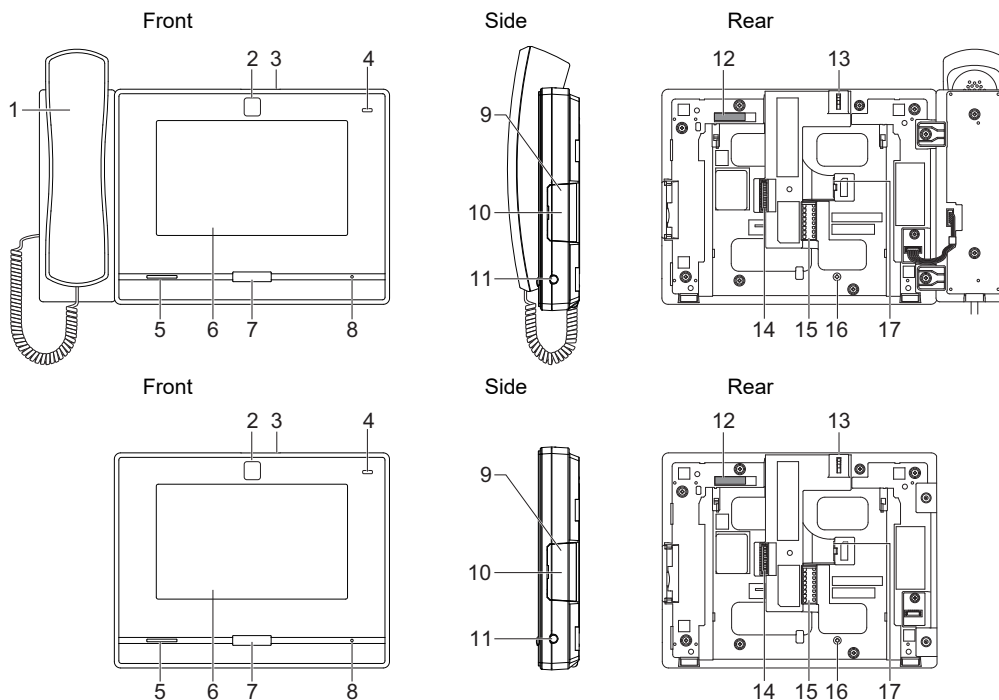





1	Handset	10	microSD card slot*1
2	Camera	11	3.5 mm jack
3	Camera privacy cover lever (on top)	12	MAC address
4	Status indicator (Orange/Blue)	13	Camera angle adjustment lever
5	Speaker	14	Option connector terminal
6	Touchscreen LCD	15	Low-voltage connection terminal
7	Home button	16	Desktop-stand fastening screw hole
8	Microphone	17	LAN port
9	Reset button*1*2		

*1 Found by opening cover.

*2 Press and hold the reset button for at least 1 second (less than 5 seconds), then release to restart (reset).

■ Indicators

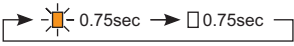
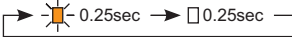
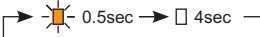
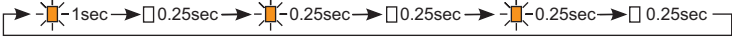
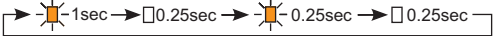
: ON,  : OFF

Name	Status (pattern)	Description
Status indicator		Booting
		Device error, Startup error
		Communication failure Line supervision and device check error
		Firmware version updating
		Initializing
Blue light		Standby(Depends on setting)



Note

- For a status other than those noted here, refer to "Operation Manual."
- The display language is English by default.

4.3 Guard Station (IXG-MK)

■ Part names

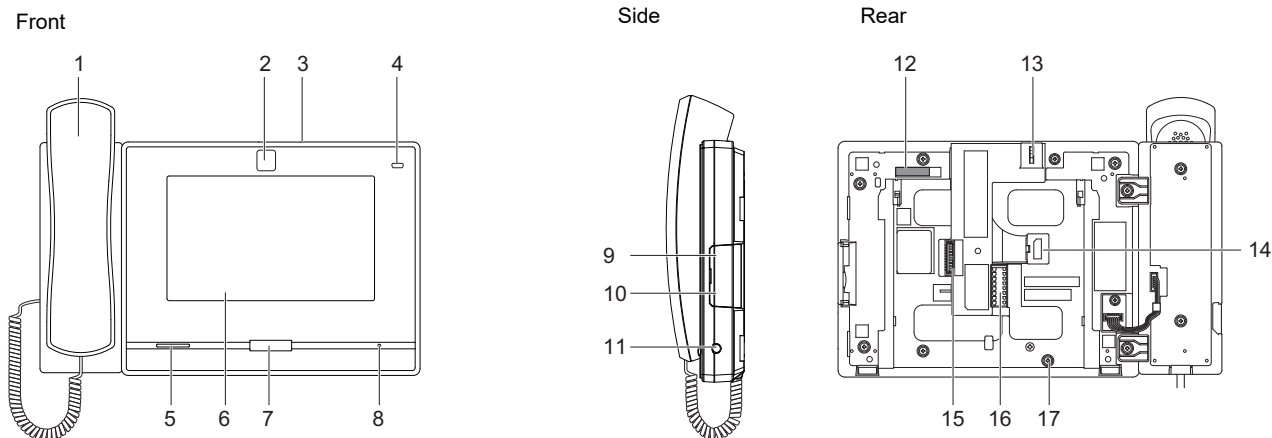





1	Handset	10	microSD card slot*1
2	Camera	11	3.5 mm jack
3	Camera privacy cover lever (on top)	12	MAC address
4	Status indicator (Orange/Blue)	13	Camera angle adjustment lever
5	Speaker	14	LAN (PoE) port
6	Touchscreen LCD	15	Option connector terminal
7	Home button	16	Low-voltage connection terminal
8	Microphone	17	Desktop-stand fastening screw hole
9	Reset button*1*2		

*1 Found by opening cover.

*2 Press and hold the reset button for 1 - 4 seconds, then release to restart station.

■ Indicators

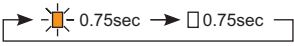
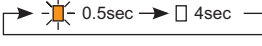
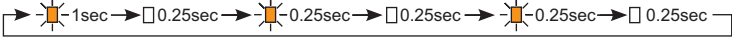
: ON, : OFF

Name	Status (pattern)		Description
Status indicator	Orange flashing		Booting
			Communication failure
			Firmware version updating
			Initializing
	Blue light		Operating normally (may not light up when in standby depending on setting)



Note

- For a status other than those noted here, refer to "Operation Manual."
- The display language is English by default.

4.4 Handset Sub Station (IX-RS-*)

■ Part names

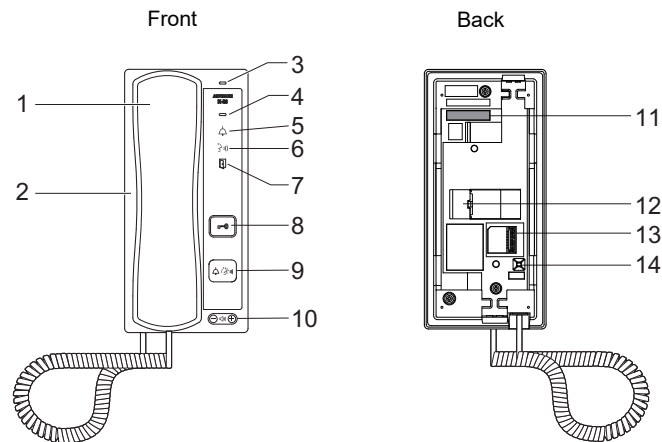

1	Handset	8	Door release button Only displayed when configured.
2	Speaker	9	Call/Talk button Can be used to call or answer depending on configuration.
3	Microphone	10	Call tone/Incoming voice volume* ¹
4	Status indicator (Orange/Blue)	11	MAC address
5	Call indicator (Green) LED lit during operation.	12	LAN port
6	Communication indicator (Orange) LED lit during operation.	13	Low-voltage connection terminal
7	Door release indicator (Green) LED lit during operation.	14	Reset button* ²

*¹ The volume can be adjusted for each of the following.

– Volume can be changed during an incoming call or in standby:

Ringtone... 0 (Off), 1 (Low) - 10 (High) (a tone is played each time it is adjusted)



– Volume can be changed during calls:



Handset Receive... 1 (Low) - 10 (High)

Hands-free Receive (also changes the paging reception and ringback tone volume)... Volume (1) to Volume (10)

*² Press and hold the reset button for 1 - 4 seconds, then release to restart station.

■ Indicators

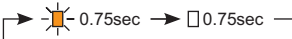
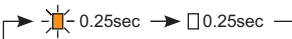
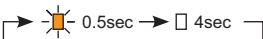
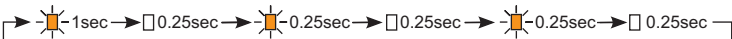
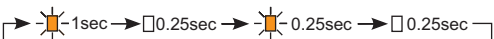
: ON, : OFF

Name	Status (pattern)	Description
Status indicator		Booting
		Device error, Startup error
		Communication failure
		Firmware version updating
		Initializing
Blue light		Standby



Note

- For a status other than those noted here, refer to "Operation Manual."

4.5 Entrance Station (IXG-DM7(-*))

■ Part names

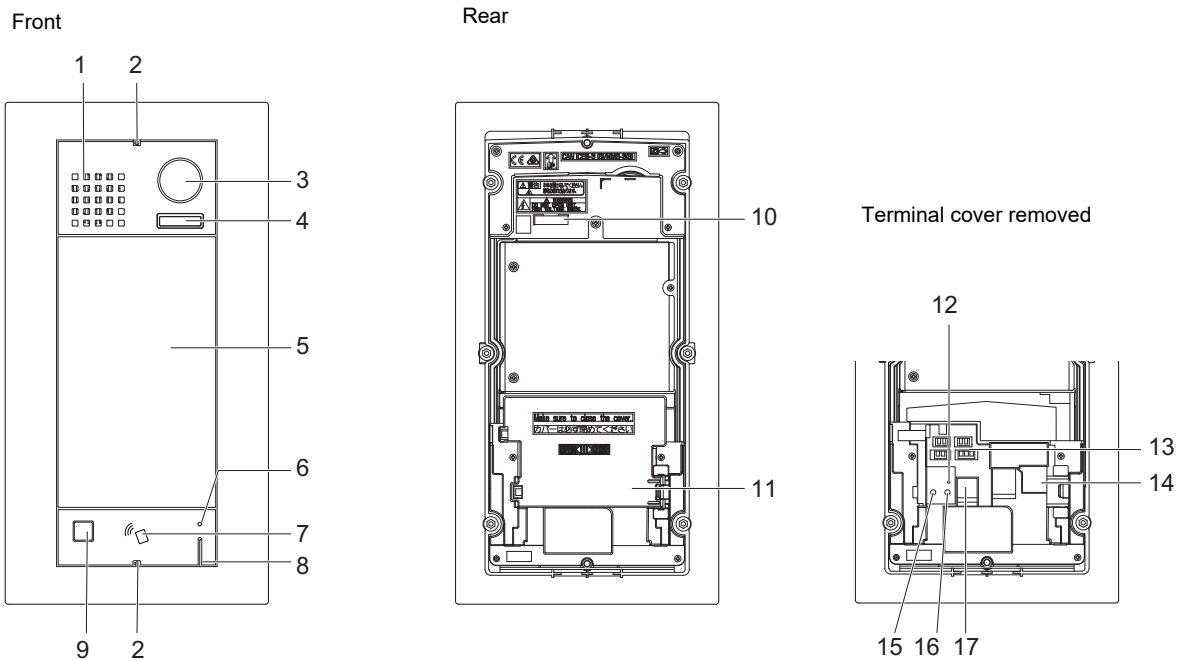

1	Speaker	10	MAC address
2	Special screw	11	Terminal cover
3	Camera	12	microSD card indicator (Red)* ³
4	LED for night illumination* ¹	13	Connectors* ³
5	Touchscreen LCD	14	LAN (PoE) port* ³
6	Card reader indicator (Red/Green)* ² (IXG-DM7-HID only)	15	Reset button* ³ * ⁴
7	Card reader (IXG-DM7-HID only)	16	microSD card release button* ³
8	Microphone	17	microSD card slot* ³
9	Sensor		

*1 Lights ON when rebooting.

Flashes when the station is booting or during ID/password initialization.

*2 Always lit ON red. If the proximity key is authenticated, it will light ON (green) for approximately 3 seconds.

*3 Found by opening terminal cover.

*4 Press and hold the reset button for 1 - 4 seconds, then release to restart station.

Note

- The display language is English by default.

4.6 Video Door Station (IX-EA, IX-EAU)/Door Station (IX-FA)

Part names

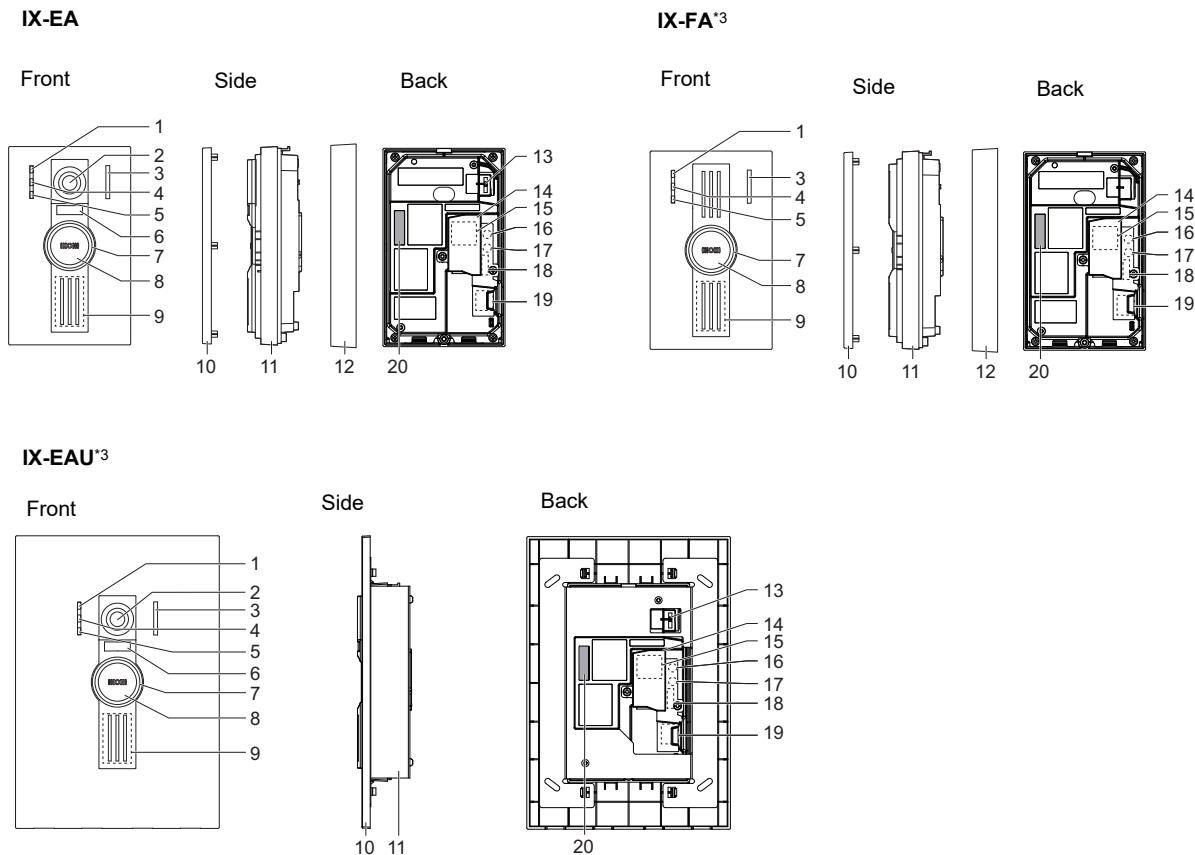



1	Call indicator (Green)	11	Main unit
2	Camera	12	Mount
3	Microphone	13	Camera angle adjustment lever
4	Communication indicator (Orange)	14	Terminal cover
5	Door release indicator (Green)	15	LAN port ^{*1}
6	LED for night illumination	16	Reset button ^{*1*2}
7	Status indicator (Orange/Blue) The ring around the button will illuminate.	17	microSD card release button ^{*1}
8	Call Button	18	Option connector terminal ^{*1}
9	Speaker	19	microSD card slot ^{*1}
10	Panel	20	MAC address





*1 Accessible when terminal cover is opened.

*2 Press and hold the reset button for 1 - 4 seconds, then release to restart station.

*3 Japan only

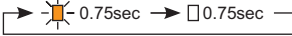
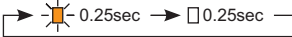
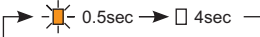
■ Indicators

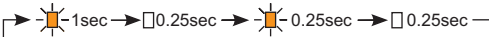
: ON,  : OFF

Name	Status (pattern)	Description
Status indicator	Orange flashing 	Booting
		Device error, Startup error
		Communication failure
		Firmware version updating
		Mounting/unmounting microSD card
		Initializing
Blue light		Standby



Note

- For a status other than those noted here, refer to "Operation Manual."

4.7 Video Door Station (IX-DA)/Door Stations (IX-BA)

Part names

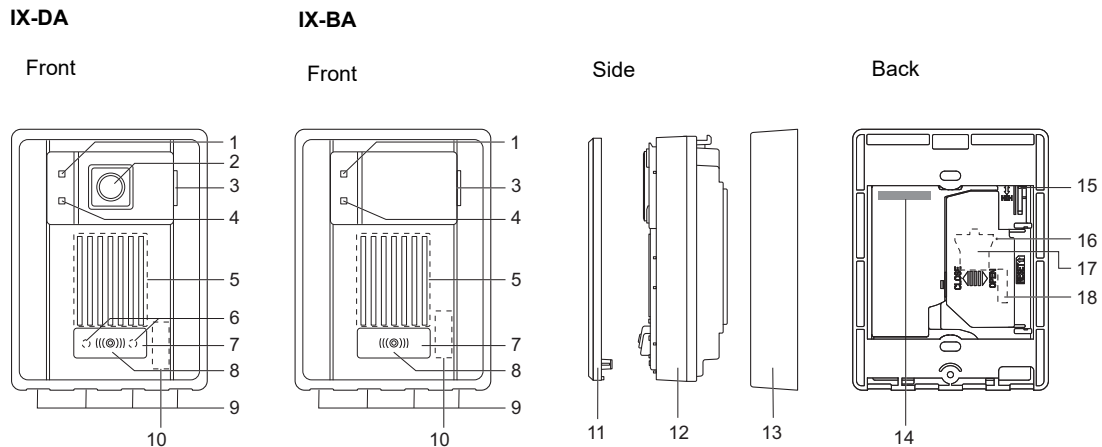

1	Call indicator (Orange)	10	MAC address (beneath the panel)
2	Camera	11	Panel
3	Microphone	12	Main unit
4	Communication indicator (Green)	13	Mounting frame
5	Speaker	14	MAC address
6	LED for night illumination	15	Camera angle adjustment lever (IX-DA only)
7	Call Button	16	Reset button ^{*1*2}
8	Status indicator (Red)	17	LAN port ^{*1}
9	Drain holes (4)	18	Connectors ^{*1}

*1 Found by opening terminal cover.

*2 Press and hold the reset button for 1 - 4 seconds, then release to restart station.

■ Indicators

☀: ON, □ : OFF

Name	Status (pattern)	Description
Status indicator	Red flashing ☀ 0.75sec → □ 0.75sec	Booting
	☀ 0.25sec → □ 0.25sec	Device error
	☀ 0.5sec → □ 4sec	Communication failure
	☀ 1sec → □ 0.25sec → ☀ 0.25sec → □ 0.25sec → ☀ 0.25sec → □ 0.25sec	Firmware version updating
	☀ 1sec → □ 0.25sec → ☀ 0.25sec → □ 0.25sec	Initializing
	Red light ☀	Standby



Note

- For a status other than those noted here, refer to "Operation Manual."

4.8 Video Door Station (IX-DV, IX-DVF(-*)) /Door Stations (IX-SSA(-*))

■ Part names

IX-DV

Front

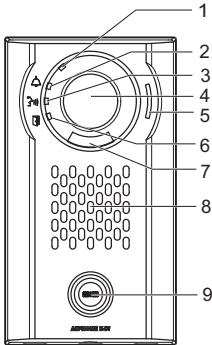

Back

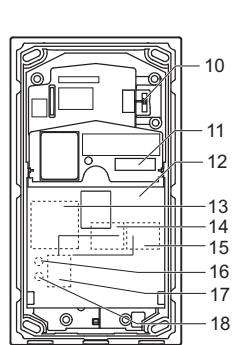

IX-DVF

Front

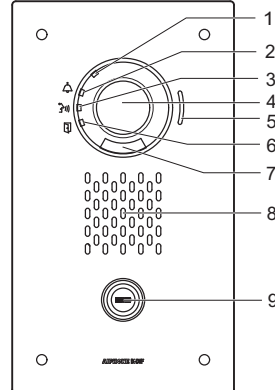

Back

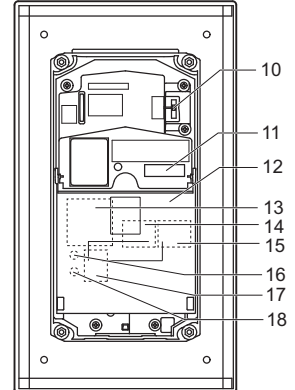

1	Status indicator (Orange/Blue)	10	Camera angle adjustment lever
2	Call indicator (Green)	11	MAC address
3	Communication indicator (Orange)	12	Terminal cover
4	Camera	13	Option connector terminal*1
5	Microphone	14	LAN2 terminal (PoE/PSE)*1
6	Door release indicator (Green)	15	LAN1 terminal (PoE/PD)*1
7	LED for night illumination	16	Reset button*1*2
8	Speaker	17	microSD card slot*1
9	Call Button Surrounding area is lit up with blue light.	18	microSD card release button*1

*1 Accessible when terminal cover is opened.

*2 Press and hold the reset button for 1 - 4 seconds, then release to restart station.

IX-DVF-2RA

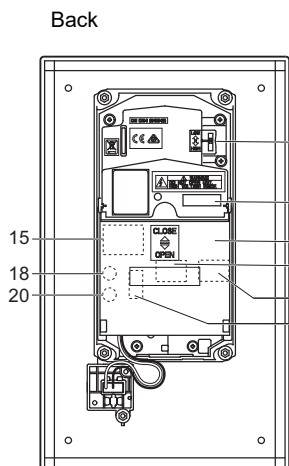
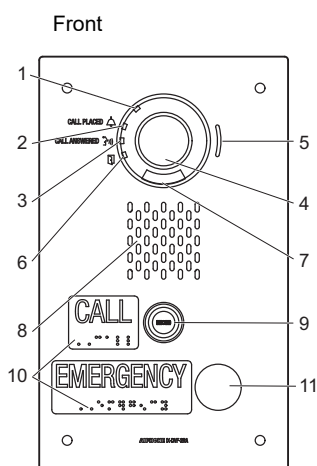

IX-DVF-RA

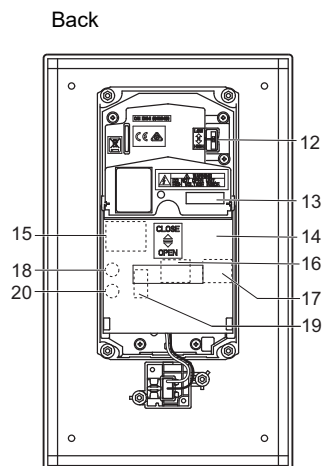
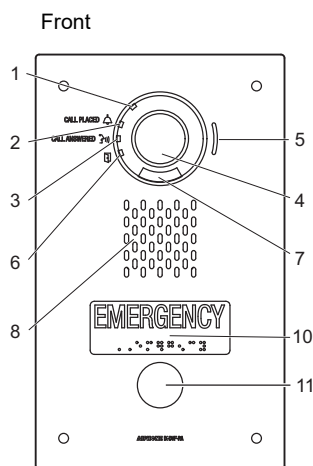

1	Status indicator (Orange/Blue)	11	Urgent call button
2	Call indicator (Green)	12	Camera angle adjustment lever
3	Communication indicator (Orange)	13	MAC address
4	Camera	14	Terminal cover
5	Microphone	15	Option connector terminal*1
6	Door release indicator (Green)	16	LAN2 terminal (PoE/PSE)*1
7	LED for night illumination	17	LAN1 terminal (PoE/PD)*1
8	Speaker	18	Reset button*1*2
9	Call Button Surrounding area is lit up with blue light.	19	microSD card slot*1
10	Braille	20	microSD card release button*1

*1 Found by opening terminal cover.

*2 Press and hold the reset button for 1 - 4 seconds, then release to restart station.

IX-DVF-P

Front

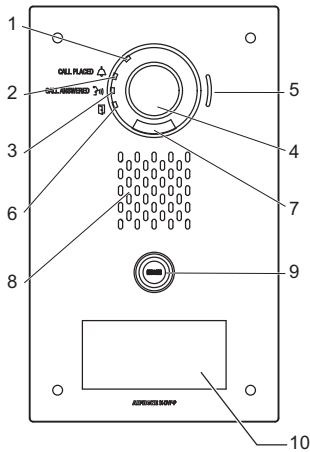

Back

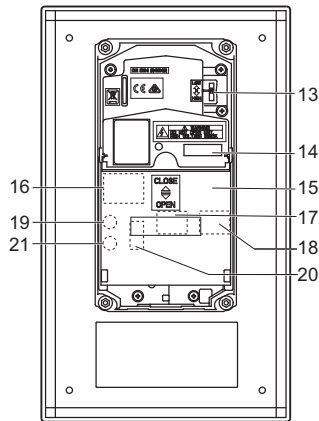

IX-DVF-L

Front

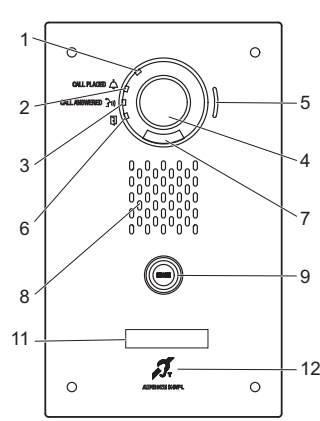

Back

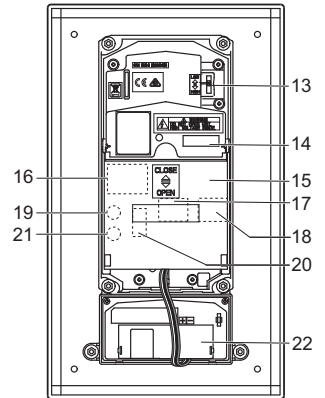

1	Status indicator (Orange/Blue)	12	Hearing aid (T mode) compatible microphone
2	Call indicator (Green)	13	Camera angle adjustment lever
3	Communication indicator (Orange)	14	MAC address
4	Camera	15	Terminal cover
5	Microphone	16	Option connector terminal*1
6	Door release indicator (Green)	17	LAN2 terminal (PoE/PSE)*1
7	LED for night illumination	18	LAN1 terminal (PoE/PD)*1
8	Speaker	19	Reset button*1*2
9	Call Button Surrounding area is lit up with blue light.	20	microSD card slot*1
10	HID reader	21	microSD card release button*1
11	Nameplate (with backlight)	22	Hearing aid unit

*1 Found by opening terminal cover.

*2 Press and hold the reset button for 1 - 4 seconds, then release to restart station.

IX-SSA

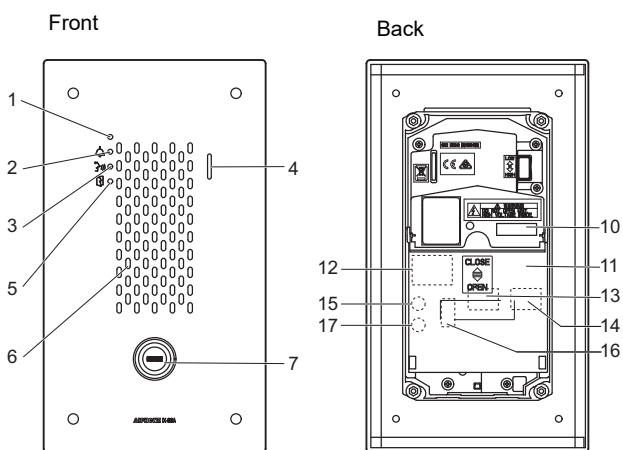

IX-SSA-2RA

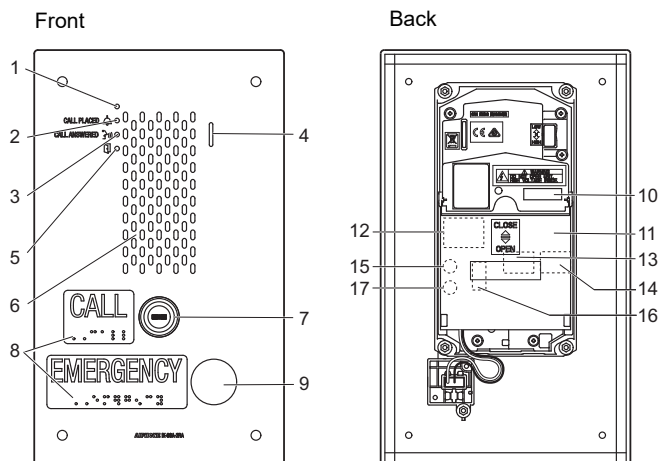

IX-SSA-RA

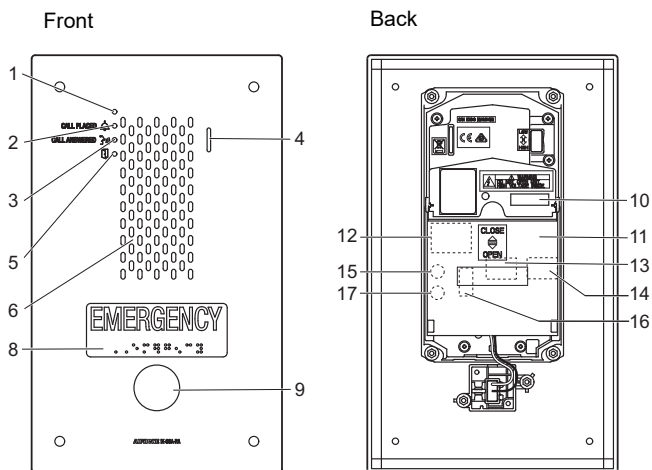





1	Status indicator (Orange/Blue)	10	MAC address
2	Call indicator (Green)	11	Terminal cover
3	Communication indicator (Orange)	12	Option connector terminal*1
4	Microphone	13	LAN2 terminal (PoE/PSE)*1
5	Door release indicator (Green)	14	LAN1 terminal (PoE/PD)*1
6	Speaker	15	Reset button*1*2
7	Call Button Surrounding area is lit up with blue light.	16	microSD card slot*1
8	Braille	17	microSD card release button*1
9	Urgent call button		

*1 Found by opening terminal cover.

*2 Press and hold the reset button for 1 - 4 seconds, then release to restart station.

■ Indicators

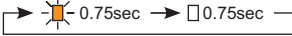
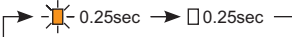
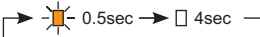
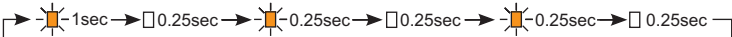
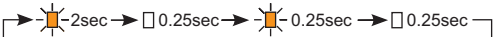
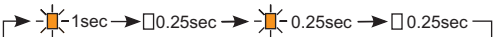
: ON, : OFF

Name	Status (pattern)	Description
Status indicator	Orange flashing 	Booting
		Device error, Startup error
		Communication failure
		Firmware version updating
		Mounting/ unmounting microSD card
		Initializing
Blue light		Standby

Note

- For a status other than those noted here, refer to "Operation Manual."

4.9 Door Stations (IX-SS-2G)

Part names

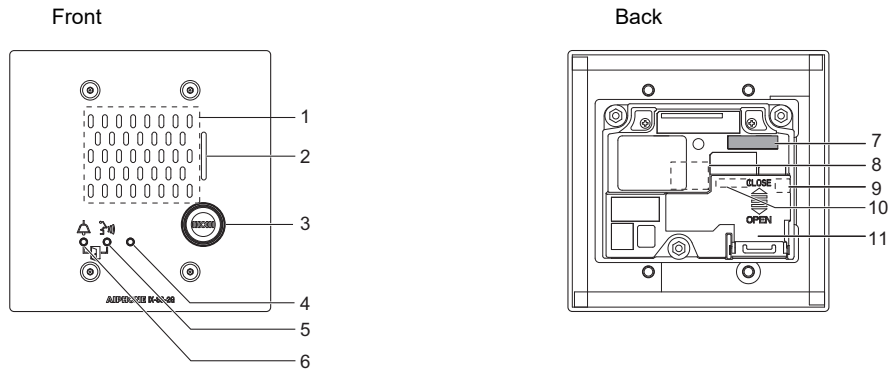

1	Speaker	7	MAC address
2	Microphone	8	LAN port* ¹
3	Call Button	9	Reset button* ^{1,2}
4	Status indicator (Orange/Blue)	10	Low-voltage connection terminal* ¹
5	Communication indicator (Orange)	11	Terminal cover
6	Call indicator (Green)		

*¹ Found by opening terminal cover.

*² Press and hold the reset button for 1 - 4 seconds, then release to restart station.

Indicators

☀: ON, □: OFF

Name	Status (pattern)	Description
Status indicator	Orange flashing ☀ 0.75sec → □ 0.75sec	Booting
	☀ 0.25sec → □ 0.25sec	Device error, Startup error
	☀ 0.5sec → □ 4sec	Communication failure
	☀ 1sec → □ 0.25sec → ☀ 0.25sec → □ 0.25sec → ☀ 0.25sec → □ 0.25sec	Firmware version updating
	☀ 1sec → □ 0.25sec → ☀ 0.25sec → □ 0.25sec	Initializing
Blue light	☀	Standby

Note

- For a status other than those noted here, refer to "Operation Manual."

4.10 Lift Control Adaptor (IXGW-LC)

■ Part names

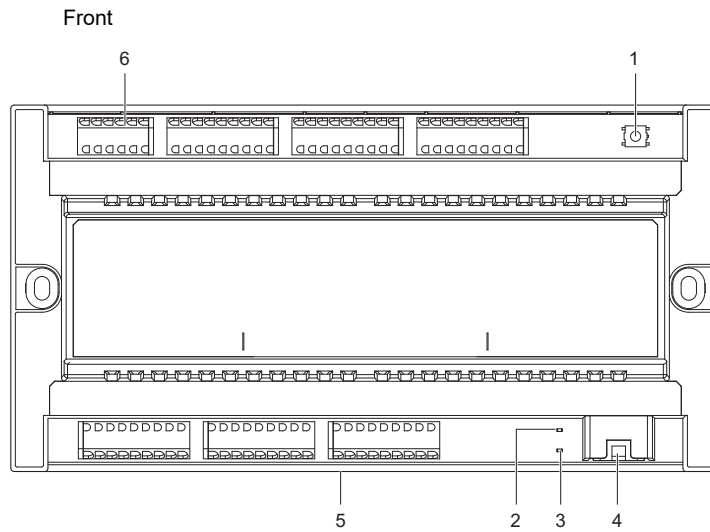



1	Reset button*1	4	LAN (PoE) port
2	Status indicator (Orange)	5	Lock release lever (Back)
3	Status indicator (Green)	6	Low-voltage connection terminal

*1 Press and hold the reset button for 1 - 4 seconds, then release to restart station.

*2 The MAC address is found on the back on the device.

■ Indicators

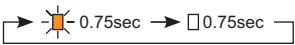
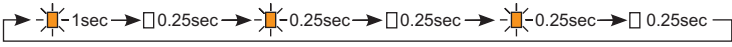
☀: ON, □ : OFF

Name	Status (pattern)		Description
Status indicator	Orange flashing		Booting
			Firmware version updating
			Initializing
	Green light		Standby

4.11 Gateway Adaptor (IXGW-GW)

■ Part names

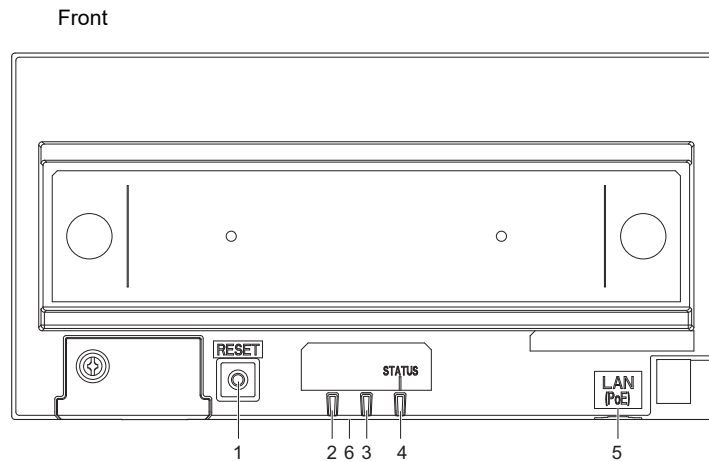

1	Reset button	4	Status indicator (Orange/Green)
2	Not used	5	LAN (PoE) port
3	Not used	6	Lock release lever (Back)

*1 Press and hold the reset button for 1 - 4 seconds, then release to restart station.

*2 The MAC address is found on the back on the device.

! Important

- Due to the features and services provided by the Gateway Adaptor and the AIPHONE IXG app, future required changes to device functionality, network communication, security, etc. may require firmware updates unavailable to the Gateway Adaptor. In this situation, the Gateway Adaptor would need to be replaced at the cost of the responsible party.

■ Indicators

☀: ON, □ : OFF

Name	Status (pattern)		Description
Status indicator	Orange light	☀	IXG Cloud Server authentication error
	Orange flashing	☀ 0.75sec → □ 0.75sec	Booting
		☀ 0.5sec → □ 4sec	Communication failure
		☀ 1sec → □ 0.25sec → ☀ 0.25sec → □ 0.25sec → ☀ 0.25sec → □ 0.25sec	Firmware version updating
		☀ 1sec → □ 0.25sec → ☀ 0.25sec → □ 0.25sec	Initializing
Green light	☀	Standby	

5. Configuring the system

The IXG System can be configured using the following methods.

- Configure the system using the "IXG Support Tool" application.
 - Install the application on a PC and use to create the configuration for all stations.
 - Search for IXG system stations on the network; assign and upload the setting file for the system.

There are two configuration modes for IXG Support Tool.

- Administrator mode: Configure all settings.
- Property Manager mode: Configure only the following settings.

Move-in Settings

- Units / Stations
- Identification
- Station List
- Mobile App List
- Network Camera List
- Group
- Called Stations (Door/Sub Stations)
- Guard Button

Move-out Settings

- Resident Move-out
- Delete Unit Information

Misc.

- Access Code
- Welcome Screen
- Absent Transfer
- Delay Transfer
- Schedule Transfer

This document describes how to configure settings in Property Manager mode. For information on Administrator mode, refer to the separate "IXG Support Tool Setting Manual: Administrator Mode."

Important

- Be sure to store the setting file that was created. If the setting file is lost, you may be charged a separate setting fee during maintenance or post-installation maintenance and service.

6. Flowcharts for configuring the system

Follow the flowchart below when changing the settings using IXG Support Tool.

Save the settings after configuring the system. Otherwise, it may become impossible to restore the settings after maintenance or after-sales servicing.

1. Set the language.

["Language \(→page 75\)"](#)



2. Download the settings from all the stations.

["Download Settings \(→page 57\)"](#)



3. Perform setup.

Follow the instructions for each setting item and perform setup.

["System Settings \(→page 77\)"](#)

If using App Integration, configure settings following the detailed explanation in "App Integration Flowchart."

["Flowcharts for Mobile App Integration \(→page 32\)"](#)



Has the "Station Number," "Station Name," or "Camera Name" been changed?

YES



NO



4. Upload the setting data to all stations.

["Upload Settings \(→page 59\)"](#)

4. Upload the setting data to the station whose settings were changed.

["Upload Settings \(→page 59\)"](#)



5. Complete

7. Flowcharts for Mobile App Integration

! Important

- Due to the features and services provided by the Gateway Adaptor and the AIPHONE IXG app, future required changes to device functionality, network communication, security, etc. may require firmware updates unavailable to the Gateway Adaptor. In this situation, the Gateway Adaptor would need to be replaced at the cost of the responsible party.
- QR code is a registered trademark of Denso Wave Incorporated.

7.1 Registering the Mobile App

The flowchart below describes the process of registering a Mobile App with a new or existing site.

1. Register the App in [“Units / Stations \(→page 78\)”](#).



2. Configure the following settings.

- Test Settings* [“IXG Support Tool Settings \(→page 52\)”](#)
- Change password at initial login [“App Integration \(→page 63\)”](#)
- Unit Name* [“Units / Stations \(→page 78\)”](#)
- Station Name [“Identification \(→page 81\)”](#)
- Open Station List [“Station List \(→page 83\)”](#)
- Create mobile app list [“Mobile App List \(→page 86\)”](#)

* Configuration is not required if it is already registered.



3. Updating the Settings to an Existing Site on the IXG Cloud Server.

[“Uploading an existing site to the IXG Cloud Server \(→page 64\)”](#)



4. Generate PDF of QR Code for App Registration.

[“Export QR Code for App Registration \(→page 68\)”](#)

* If there is already a Tenant Station in the unit, send the QR Code to the Tenant Station.

[“Applying QR Code for App Registration to a station \(→page 67\)”](#)





5. Upload the setting file to the station.

[“Upload Settings \(→page 59\)”](#)



6. Register the Mobile App by scanning the QR code.

7.2 Adding a Mobile App to Each Unit

The flowchart below describes the process of registering a Mobile App with a unit that is already connected to the IXG Cloud Server.

! Important

- Refer to [“Registering the Mobile App \(→page 32\)”](#) for information on registering the first Mobile App in each unit.

1. Add the "App" in [“Units / Stations \(→page 78\)”](#).



2. Configure the following settings.

- Station Name [“Identification \(→page 81\)”](#)
- Open Station List [“Station List \(→page 83\)”](#)



3. Updating the Settings to an Existing Site on the IXG Cloud Server.

[“Uploading an existing site to the IXG Cloud Server \(→page 64\)”](#)



4. Generate PDF of QR Code for App Registration.

[“Export QR Code for App Registration \(→page 68\)”](#)



5. Upload the setting file to the station.

[“Upload Settings \(→page 59\)”](#)



6. Register the Mobile App by scanning QR code.

* For a residential Mobile App where a Tenant Station is installed in the residence, touch **[SETTINGS] - [Register Apps]** on the Home Screen of the Tenant Station to display the QR code.

7.3 When the type of mobile device registered to a Residential unit was replaced

The flowchart below describes the process of replacing a Mobile App.

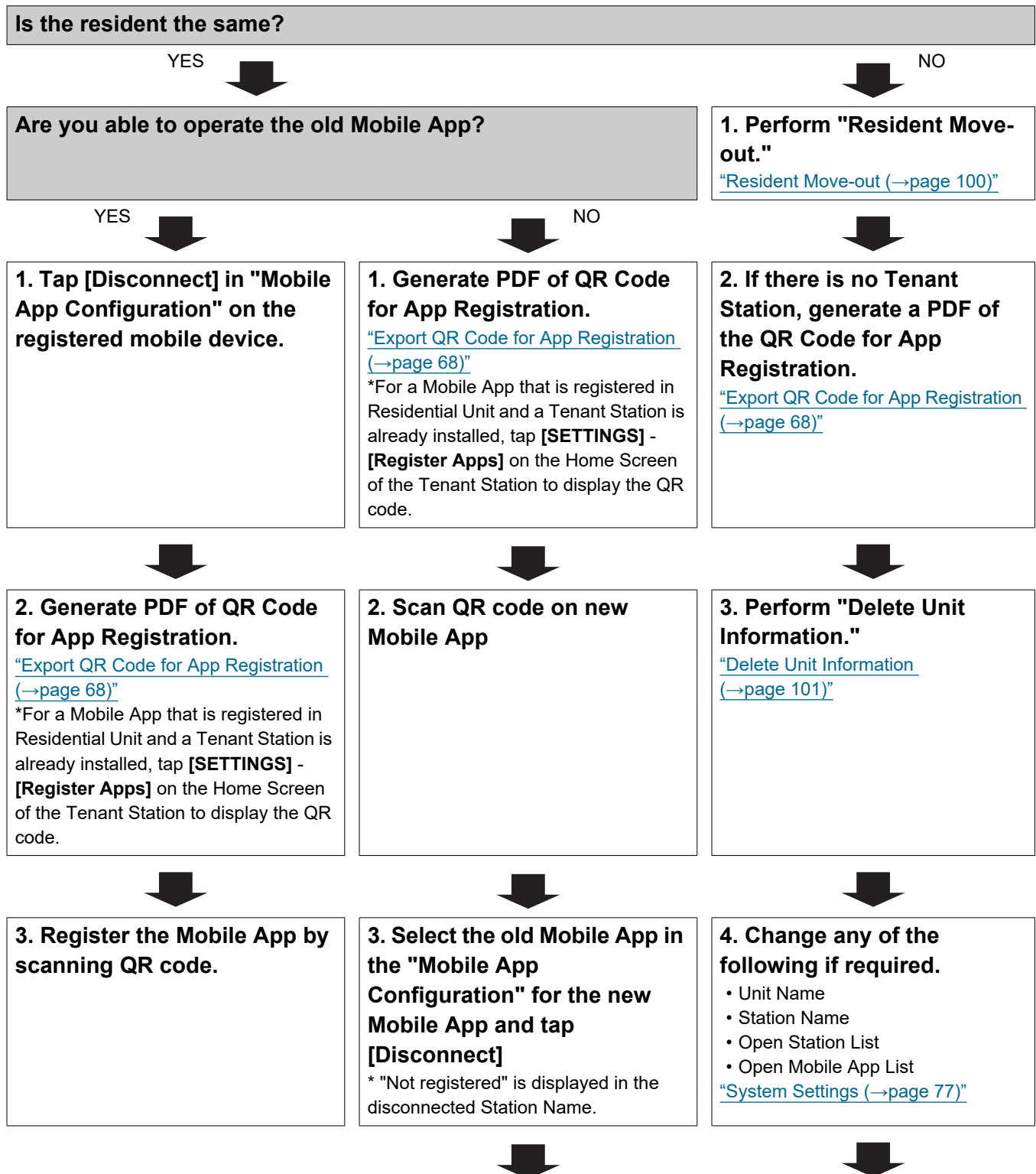



4. Tap the disconnected Station Name in the "Mobile App Configuration" for the new Mobile App and tap [Connect]



5. Upload the settings to the IXG Cloud Server.
["Uploading an existing site to the IXG Cloud Server \(→page 64\)"](#)



6. Upload the setting file to the station.
["Upload Settings \(→page 59\)"](#)



7. Register the new Mobile App by scanning the QR code.

7.4 When the type of mobile device registered to a Guard or a Commercial unit was replaced

The flowchart below describes the process of replacing a Mobile App.

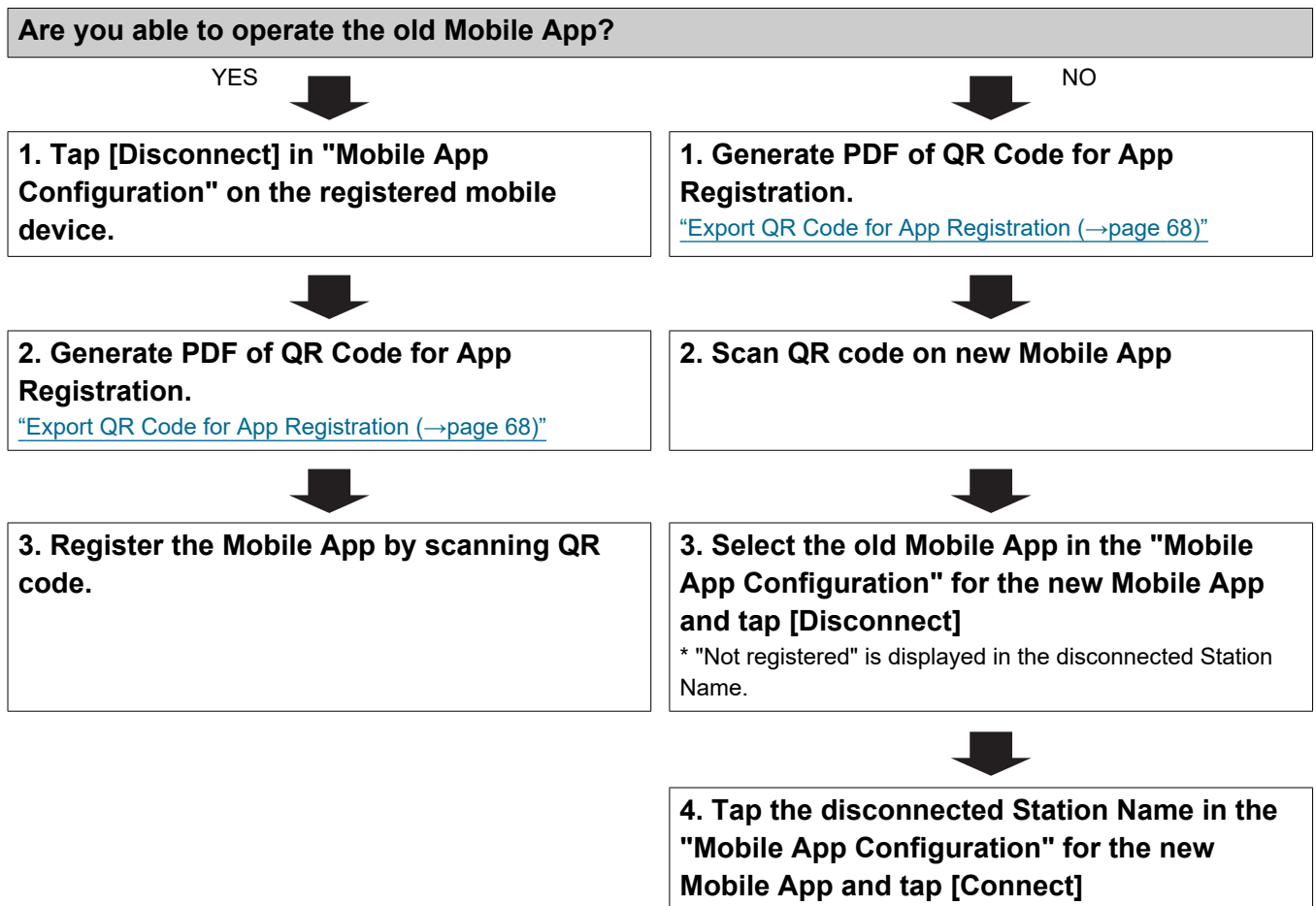

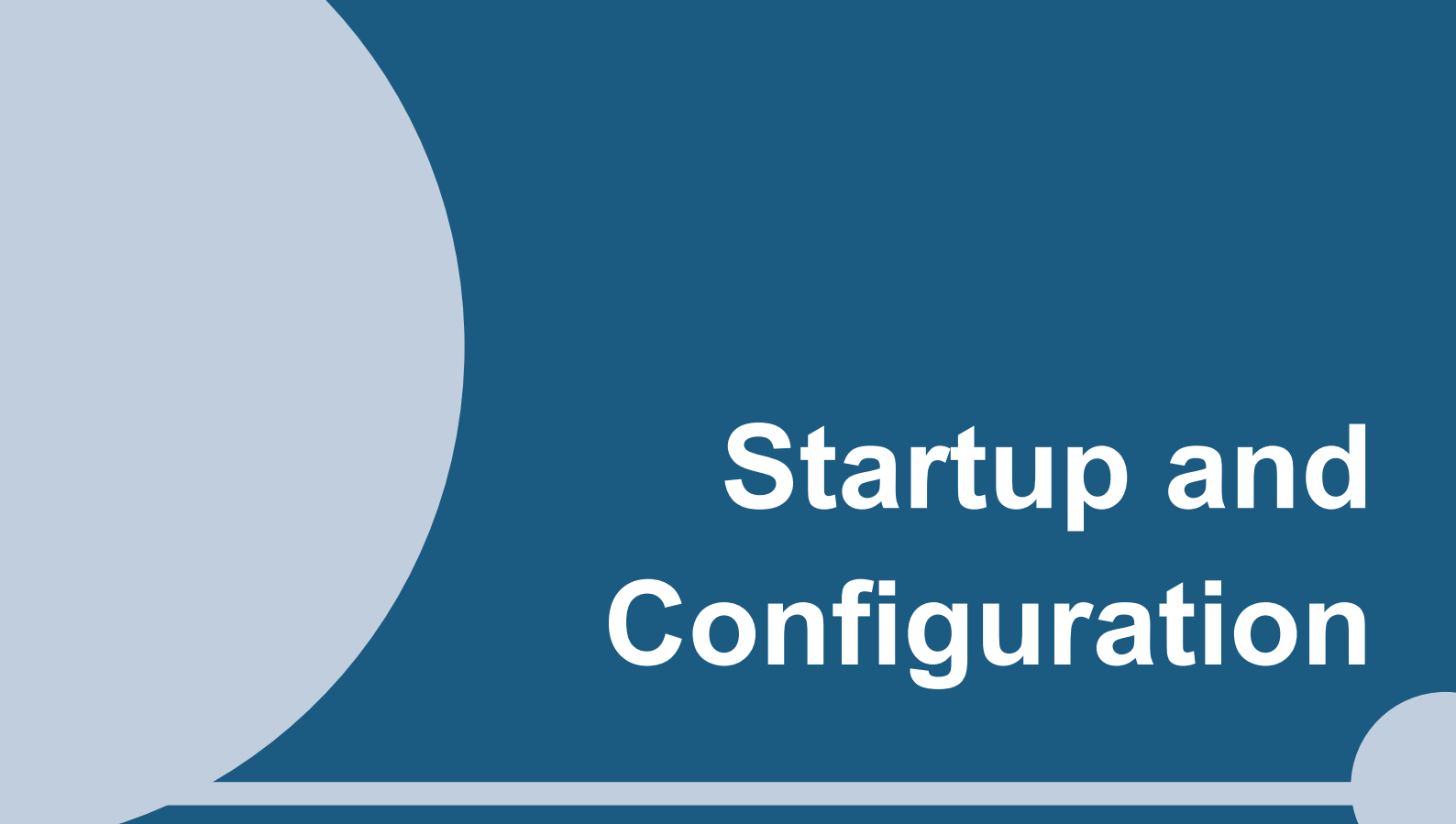

Startup and Configuration

1. System requirements

PC requirements for using the IXG Support Tool.

Operating System	Windows 7 Professional (SP1), Windows 7 Enterprise (SP1), Windows 7 Ultimate (SP1) Windows 8, Windows 8 pro, Windows 8 Enterprise Windows 8.1, Windows 8.1 pro, Windows 8.1 Enterprise Windows 10 Home, Windows 10 Pro, Windows 10 Enterprise
CPU	32 bit (x86) processor or 64 bit (x64) processor of 1 GHz or higher
Memory	4 GB RAM or higher
Resolution	1280x768 or greater



Note

- Set the display size setting of your PC to “100%”.
If set to a setting other than “100%”, the screen of the IXG Support Tool may not be displayed correctly.

2. Installing IXG Support Tool

1. Access our Web site at <https://www.aiphone.net/product/support/> and download the IXG Support Tool to your PC.
2. Double-click the downloaded file ("AIPHONE_IXG_SupportTool_Setup.exe") to install IXG Support Tool.

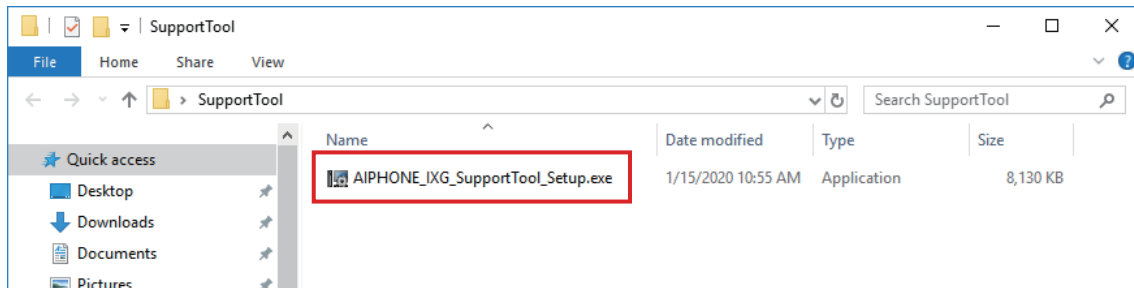

3. Select the components to install for IXG Support Tool, and then click **[Next]**.

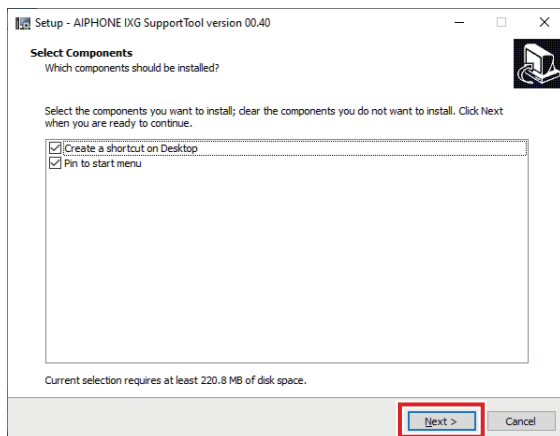

4. Click **[Finish]**.

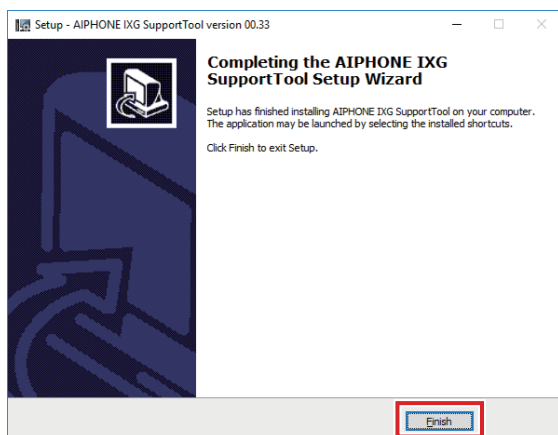

- IXG Support Tool is now installed.

3. Login and registration of the station

1. Double-click any of the following.
 - The "AIPHONE IXG SupportTool" shortcut that was created on the desktop
 - "AIPHONE IXG SupportTool" in the Start Menu
 - "Local Disk (C)" - "Program Files" - "Aiphone" - "IXG" - "SupportTool" - "AIPHONE_IXG_SupportTool.exe"

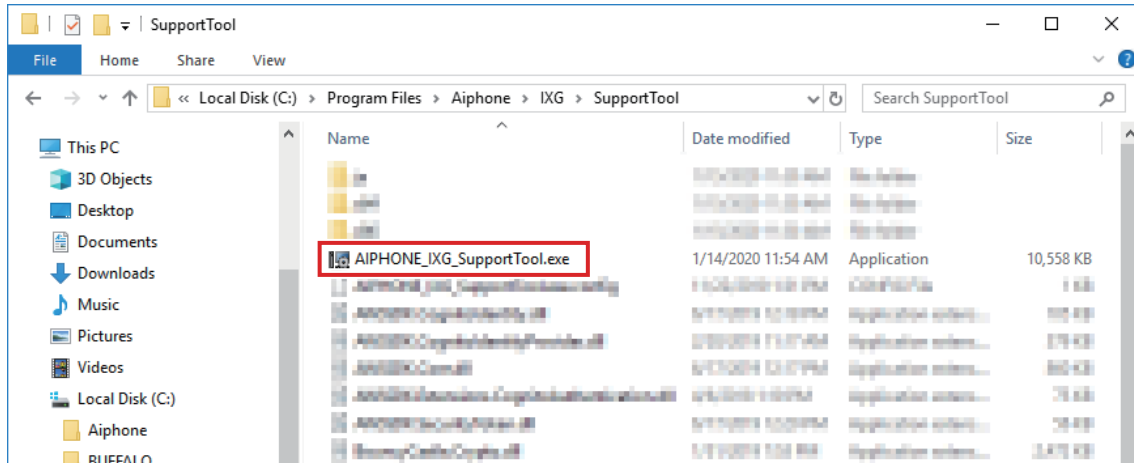

2. Select "Property Manager."
 - For information on Administrator mode, refer to the separate "IXG Support Tool Setting Manual: Administrator Mode."

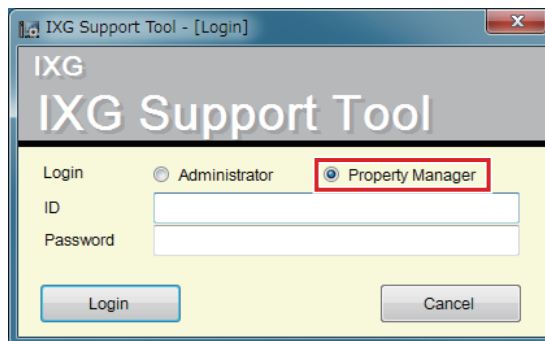

3. Enter "ID" and "Password," and click **[Login]**.
 - The "Property Manager Settings" screen is displayed.
 - The setting data configured during the previous login session will be shown.
 - The default ID and Password are "admin."

4. How to Configure

After logging into IXG Support Tool, the Settings screen is displayed. The Settings screen is used to configure settings.

- Depending on PC and OS being used, the window may be slightly different.
- After configuration, refer to the "Operation Manual" for each station and confirm operation.

4.1 Settings window

Settings screen sample

All stations in the system can be configured using the table.

Update: Click to save the settings.

Menu bar: Allows you to create new setting data. "[Menu bar](#) ([→page 47](#))"

Information: Click to display notes.

Title bar: Displays the system name and title when editing settings.

Building Number	Unit Number	Station Name	System Information				System Information Required settings			
			Number	Name	Type	Total	Station Number / Station Name / Station Type			
01	002	Master Station1	01	Inside Area 002	Audio Protocol	1	0010 / Entrance Station1 / IXG-DM7(-*)	0020 / Master Station1 / IX-MV7-*	0021 / Mast	U
					Video Protocol	1				U
01	002	Master Station2	01	Inside Area 002	Audio Protocol	1		U		
					Video Protocol	1		U		
01	106	Master Station1	01	Inside Area 002	Audio Protocol	2		U		U
					Video Protocol	2		U		U

Settings menu: Displays a list of titles. When you click a title that you want to configure, the corresponding Settings screen is displayed.

Settings screen: The Settings screen for the currently selected title is displayed.

Note

- Settings which cannot be modified will be grayed out.

4.2 How to Configure

1. Click the title to be configured.
 - The Settings window for that particular title will be shown.
2. Enter setting values for each entry.
 - The selected field will turn orange.
 - When changing the settings, the field will turn pink.
 - Some titles allow copy and paste.

Building Number	Unit Number	Station Type	Station Settings	
			Identification	
			Station Number	Station Name
01	001	IXG-DM7(-*)	0010	Entrance Station1
01	002	IX-MV7-*	0020	Master Station3
01	002	IX-MV7-*	0021	Master Station2

! Important

- Be sure to input the settings for entries in red. Use the default values, unless a change is necessary.
- Select an entry field and press the F1 key to display an explanation screen.

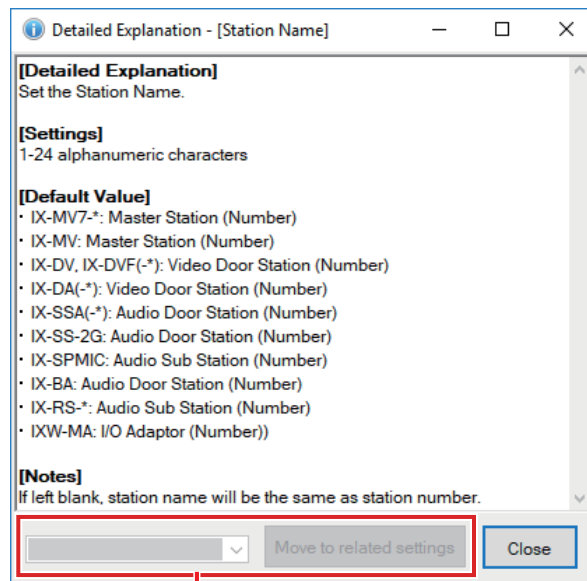

Move to related item: This allows you to move to the Settings screen for related entries.

- Pressing [Ctrl] + [F] displays the Search window, which allows the search function to be used. Enter the text to search and click **[Find Next]** to move to the applicable cell.
-  is displayed when the cursor is moved over an entry. Clicking this allows you to use the filter function. Select what to display and then click **[Apply]** to display only the applicable information.

Building Number	Unit Number	Station Type	Station Settings	
			Identification	
			Station Number	Station Name
01	001			
01	002			
01	002			
01	003			
01	101			
01	101			
01	101			
01	102	IXG-2C7(-*)	1020	Tenant Station1

(Select All)

Intercom App

IX-DV,IX-DVF(-*)

IXG-2C7(-*)

IXG-DM7(-*)

IXGW-GW

IXGW-LC

IX-MV7-*

B Text Filter

3. When you are done configuring on this screen, click **[Update]** to save the settings.

- To cancel all settings, click another title in the Setting menu.
- If there is an error when clicking **[Update]**, the error message will be shown and the settings will not be allowed to be saved.

The field will be shown in red if there is an error in the settings.

Building Number	Unit Number	Station Type	Station Settings	
			Identification	
			Station Number	Station Name
01	001	IXG-DM7(-*)	0010	Entrance Station1
01	002	IX-MV7-*	0020	Master Station_1
01	002	IX-MV7-*	0021	Master Station2
01	002	IX-DV,IX-DVF(-*)	0022	Video Door Station1

Required settings.

- If another title is selected without clicking **[Update]**, the system will prompt whether to save the settings. Click **[Yes]** to save, or click **[No]** to display another title without saving.
- Click **[Cancel]** to return to the previous screen.

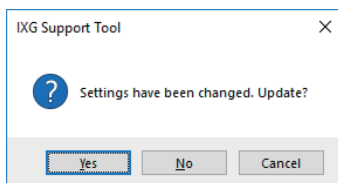

4. Perform Steps 1 - 3 for other titles as well.

5. System settings list

The following items can be configured using IXG Support Tool.

The symbols indicate the following:

- ◆: Be sure to enter a setting value. Use the default values, unless a change is necessary.
- ♣: The setting item information can be copied.
 - The following table provides an overview of IXG Support Tool. The content, how they are displayed, and the order of entries may vary from the actual screens.
 - Download and back up the setting file [“Exporting the IXG Support Tool System Configuration \(→page 50\)”](#) in case post-installation maintenance and service is required, and store it in a safe place where it will not be lost. If a backup has not been performed, it may not be possible to recover the data during after-sales service.

Setting items				Reference pages
Site Settings (Move-in Settings)				
Units / Stations	-	-	Unit Name◆	79
			First Name (Residential only)	80
			Last Name (Residential only)	80
			App (Guard, Commercial, Residential only)	80
Station Information (Move-in Settings)				
Identification	-	-	Station Number◆	81
			Station Name◆	82
System Information (Move-in Settings)				
Station List	-	-	-	83
Mobile App List	-	-	-	86
Network Camera List	Network Camera Registry	-	Camera Name◆	89
			Hostname	90
			IP Address (IPv4)◆	90
			IP Address (IPv6)◆	90
			ID◆	90
			Password◆	90
Group	Configuring a Group	-	-	93
Call Settings (Move-in Settings)				
Called Stations (Door/Sub Stations)	-	-	-	95
Guard Button	-	-	Select Station	99
			Mobile App	99

Setting items				Reference pages
Move-out Settings (Move-out Settings)				
Resident Move-out	-	-	-	100
Delete Unit Information	-	-	-	101
Entrance Station Settings (Misc.)				
Access Code	Add Access Code	-	-	104
	Delete Access Code	-	-	105
Welcome Screen	Welcome Screen Wallpaper	-	-	106
	Image 1	-	Display	107
			File name	107
Transfer Settings (Misc.)				
Absent Transfer	-	-	Absent Transfer	108
			Transfer Destination List	111
			Re-Transfer Destination	117
Delay Transfer	-	-	Delay Transfer	110
			Delay Time [sec]◆	110
			Transfer Destination List	111
			Re-Transfer Destination	111
Schedule Transfer	-	-	Schedule Transfer	112
			Weekly Schedule	-
	Re-Transfer Destination	113		
	Start Time	114		
	End Time	114		
	Daily Schedule	-	Transfer Destination List	117
			Re-Transfer Destination	117
			Start Time	117
End Time			118	

Menu bar

Important

- The symbols indicate the following:
 - ◆: Be sure to enter a setting value. Use the default values, unless a change is necessary.

1. File

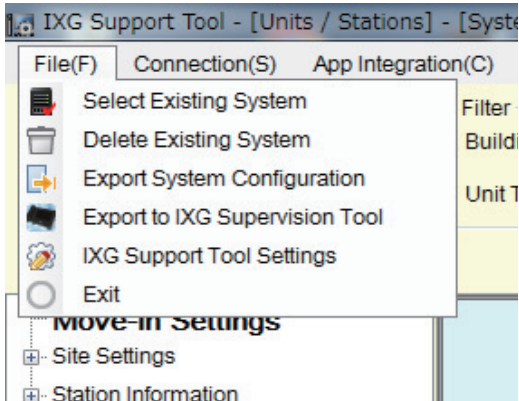

1.1 Select Existing System

Edit a setting file that already exists. This allows you to load a setting file that was saved. Select "File" - "Select Existing System." The "System Selection" screen will be displayed.

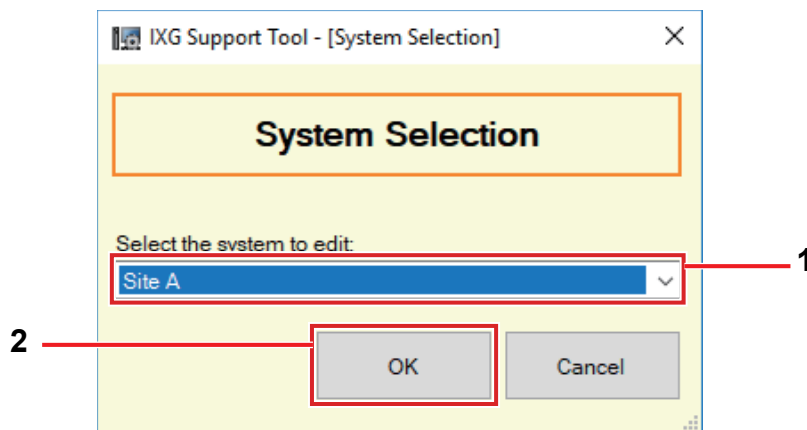

1. Select the system (site name) for the setting file to edit.
2. Click **[OK]**.
 - In the Setting window, the selected setting data will be shown.
 - Click **[Cancel]** to quit without selecting a system.

1.2 Delete Existing System

Delete created setting data.

Select "File" - "Delete Existing System." The "Delete System" screen is displayed.

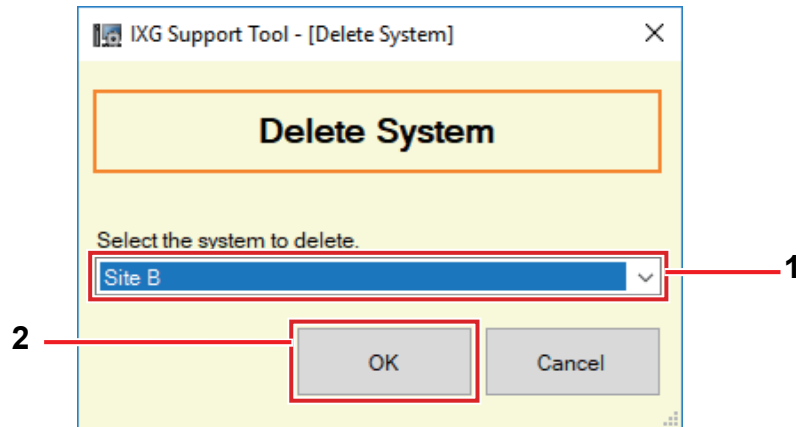

1. Select the system (site name) for the setting file to delete.
2. Click **[OK]**.
 - Delete the selected setting data.
 - Click **[Cancel]** to quit without deleting a system.
3. Click **[OK]**.
 - Click **[Cancel]** to return to the "Delete System" screen.

1.3 Exporting the IXG Support Tool System Configuration

Backup setting files created in IXG Support Tool.

If the settings are lost, it may be impossible to restore them after maintenance or after-sales servicing.

Select "File" - "Export System Configuration." The "Export Settings" screen is displayed.

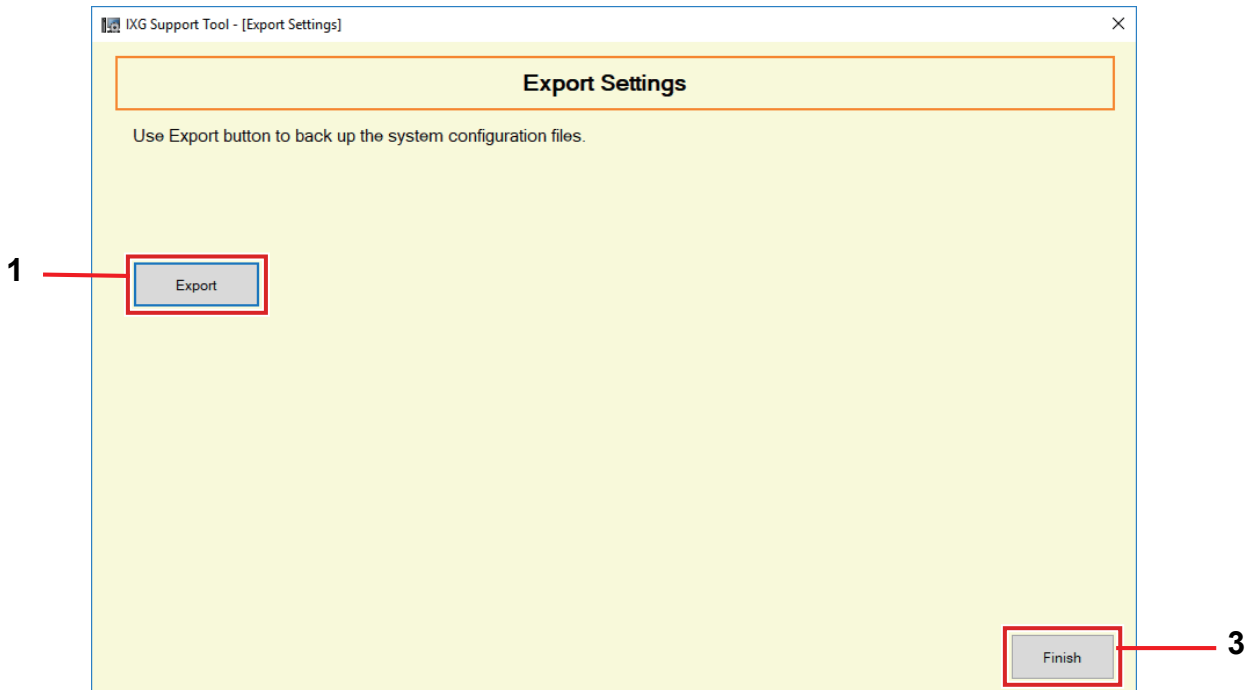

1. Click **[Export]**.
2. Select the folder where the setting file is saved and click **[OK]**.
 - A folder with the name specified in "Site Name" will be created in the specified directory, and the system configuration file will be saved inside as a hidden file.
Copy the entire "Site Name" folder to store the setting file.
 - Click **[Cancel]** to return to the "Export Settings" screen without saving the setting file.
3. Click **[Finish]**.

1.4 Outputting IXG Supervision Tool Data

To use registered station information with the IXG Supervision Tool, output the file in Address Book format. Select "File" - "Export to IXG Supervision Tool" to display the following screen.



1. Click **[Browse]** and select the folder where the setting file will be saved.
2. Click **[Export]**.
3. Click **[OK]**.
 - The setting file will be saved as "SettingAddressList.txt."
 - Information for stations without configured IP addresses will not be output.

1.5 IXG Support Tool Settings

Select "File" - "IXG Support Tool Settings." The "IXG Support Tool Settings" screen will be displayed.

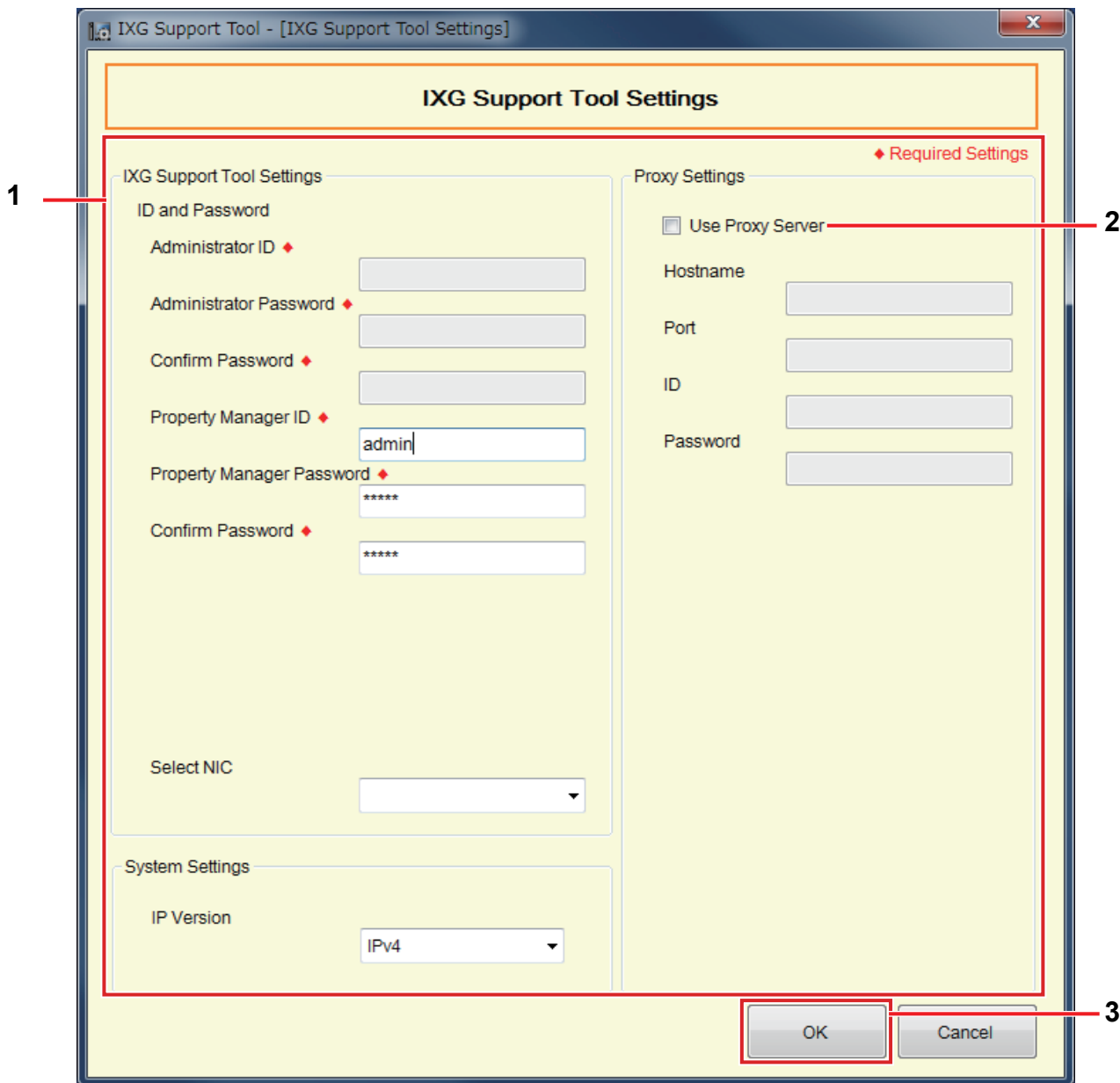

How to configure IXG Support Tool Settings

1. Configure each item.
2. If a proxy server is used to access the IXG Cloud Server, check the "Use Proxy Server" box and enter the required information.
3. Click [OK].
 - Click [Cancel] to exit.

■ Administrator ID◆

Description	Not used
-------------	----------

■ Administrator Password◆

Description	Not used
-------------	----------

■ Confirm Password◆

Description	Not used
-------------	----------

■ Property Manager ID◆

Description	Configure the ID used to login to IXG Support Tool in Property Manager mode.
Settings	1-32 alphanumeric characters
Default value	admin

■ Property Manager Password◆

Description	Configure the password used to login to IXG Support Tool in Property Manager mode.
Settings	1-32 alphanumeric characters
Default value	admin

■ Confirm Password◆

Description	Enter the "Property Manager Password" again.
Settings	1-32 alphanumeric characters
Default value	admin

■ Select NIC

Description	Select the network interface card (NIC).
Settings	Select the NIC used for the PC.
Default value	-

■ IP Version

Description	Choose the protocol for IXG Support Tool.
Settings	<ul style="list-style-type: none"> • IPv4 • IPv6
Default value	IPv4

■ Hostname

Description	Enter the IP address of the proxy server.
Settings	1-255 alphanumeric characters
Default value	-

■ Port

Description	Enter the port number of the proxy server.
Settings	1-5 digits
Default value	-

■ ID

Description	Enter the ID used for proxy authentication.
Settings	1-255 alphanumeric characters
Default value	-

■ Password

Description	Enter the password used for proxy authentication.
Settings	1-255 alphanumeric characters
Default value	-

1.6 Exit

Select "File" - "Exit" to close IXG Support Tool.

2. Connection

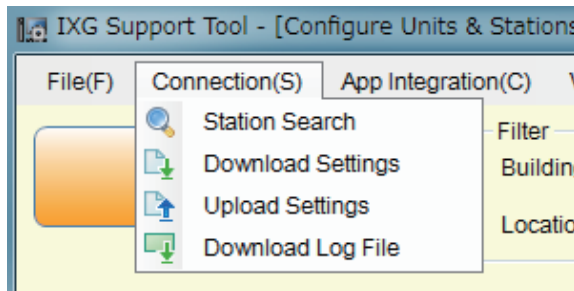

2.1 Station Search

Search the stations in IXG and IX Systems connected in the network to show the list.

1. Connect the PC to a network on the same segment as the system.
 - Set this to the same IP version as the system. Refer to [“IXG Support Tool Settings \(→page 52\)”](#) for information of configuring the IP version.
2. Select "Connection" - "Station Search". The stations searched are displayed on the "Station Search" screen. (Searching may take several minutes.)
 - The stations without power and the stations in the process of initialization will not be subject to search.
 - Search up to 9999 stations at a time.
 - Stations on other segments cannot be searched.
 - Click **[Search]** to search again.

Station Search

Search results within the local network.

Station List							Required settings.
Building Number	Unit Number	Station Name	Station Type	IP Address	MAC Address	Firmware Version	Sub Firmware Version (for IXG-DM7)
		Gateway Adaptor1	IXGW-GW	192.168.1.41	00:0B:AA:44:00:1A	0.19	
01	101	Video Door Station1	IX-DV,IX-DVF(-*)	192.168.1.17	00:0B:AA:27:00:3A	C.05	
01	101	Tenant Station1	IXG-2C7(-*)	192.168.1.15	00:0B:AA:3C:00:57	0.73	
01	101	Tenant Station2	IXG-2C7(-*)	192.168.1.16	00:0B:AA:3C:00:5E	0.73	
		Entrance Station1	IXG-DM7(-*)	192.168.1.10	00:0B:AA:41:00:7D	0.72	

2.2 Download Settings

Obtain (download) settings from a station.

Downloading can be performed only if "Association Settings" have been configured in advance in Administrator mode.

Select "Connection" - "Download Settings." The "Setting File Download" screen will be displayed.

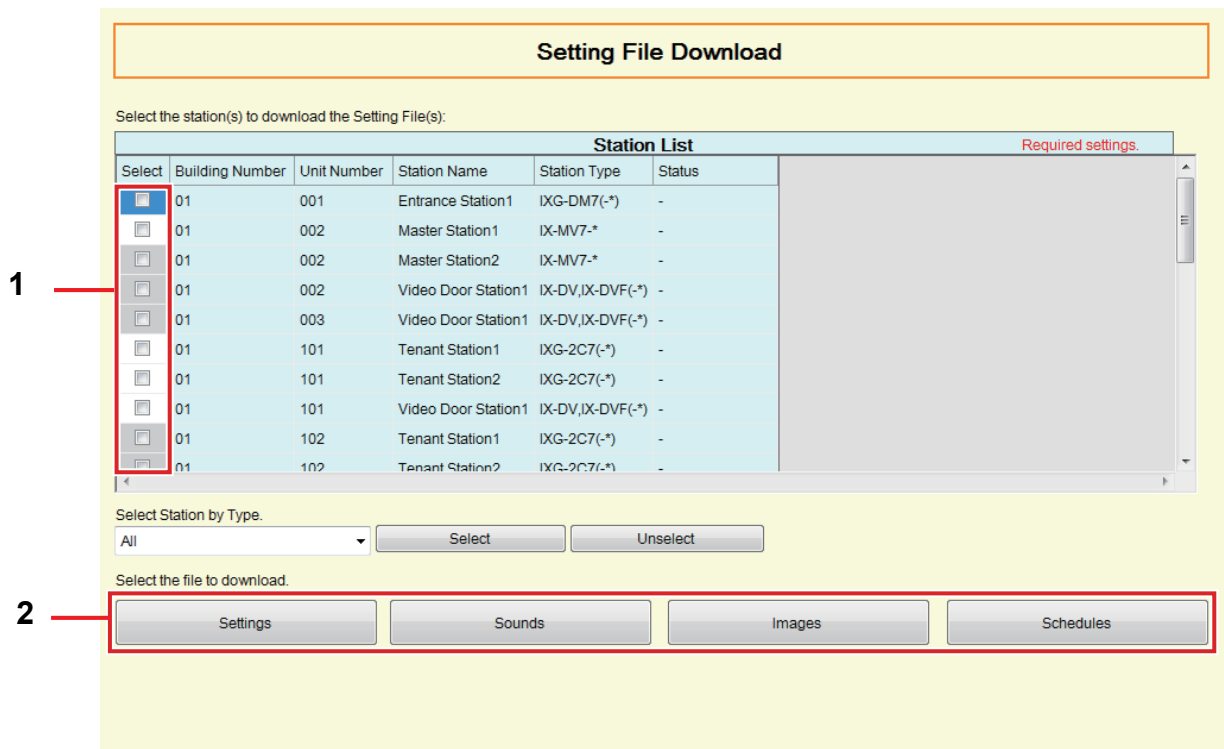

How to obtain settings

1. Select the station from which to download the setting file from "Station List." (Multiple selections allowed.)
 - To select or unselect stations in a batch, choose the station type and click **[Select]** or **[Unselect]**.
 - A station can be selected only if "Association Settings" have been configured for the station in Administrator mode.
2. Download the file.
 - [Settings]**: Download only the setting file.
 - [Sounds]**: Download the setting file and audio file for a custom tone.
 - [Images]** (IXG-DM7(-*) only): Download the setting file and the image file for Welcome Screen Settings.
 - [Schedules]** (IX-MV7-*, IXG-MK only): Download transfer and other schedule setting files.

3. Click **[OK]**.

- Click **[Cancel]** to return to the "Setting File Download" screen without downloading.

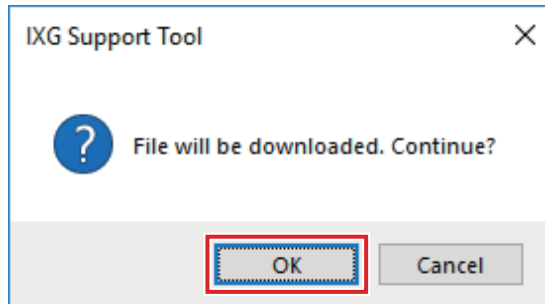
**4.** Click **[OK]**.

- The file download result is displayed in "Station List" - "Status."
 - In Process: The file is in the process of downloading.
 - Success: Download is completed.
 - Failed: Download failed. Try downloading again.
 - Unavailable: This is displayed when a file that cannot be uploaded to a station is selected to download in Step 2.
- Downloaded files are saved as follows in "Local Disk (C)" - "users" - "public" - "Documents" - "Aiphone" - "IXG" - "SupportTool" - "SystemData."
 - Setting file: "NewIXSystem(Set Site Name).db"
 - Sound file: Saved as a WAV file in "(Set Site Name)" - "Setting (Hidden Folder)" - "(Station Number)"
 - Image file: Saved as a PNG file in "(Set Site Name)" - "Setting (Hidden Folder)" - "(Station Number)"
 - Schedule file: Saved inside "(Set Site Name)" - "Setting (Hidden Folder)" - "(Station Number)" as "SCHED_CHIME.txt," "SCHED_GROUP.txt," "SCHED_OUTPUT.txt," "SCHED_TRANSFER_DATA.txt," or "SCHED_REC.txt" (the saved content differs depending on the station).

2.3 Upload Settings

Upload settings created using IXG Support Tool onto the station.

Uploading can be performed only if "Association Settings" have been configured in advance in Administrator mode. Select "Connection" - "Upload Settings." The "Setting File Upload" screen will be displayed.

! Important

- If a custom tone/image was registered, be sure to upload each file to the station in "Sounds" - "Images." The following will occur if only the setting file is uploaded.
 - The default tone will play when the operation in which the custom tone was set is performed.
 - "Download Settings" will fail.
 - "Upload Settings" will fail.

Setting File Upload

Select the station(s) to upload the Setting File(s):
If you change the maximum simultaneous calls and upload the settings to the gateway adapter, the device will restart. It may take up to 10 minutes for the restart to complete.

Select	Building Number	Unit Number	Station Name	Station Type	Status	Required settings.
<input checked="" type="checkbox"/>	01	001	Entrance Station1	IXG-DM7(-*)	-	
<input type="checkbox"/>	01	002	Master Station1	IX-MV7-*	-	
<input type="checkbox"/>	01	002	Master Station2	IX-MV7-*	-	
<input type="checkbox"/>	01	002	Video Door Station1	IX-DV,IX-DVF(-*)	-	
<input type="checkbox"/>	01	003	Video Door Station1	IX-DV,IX-DVF(-*)	-	
<input type="checkbox"/>	01	101	Tenant Station1	IXG-2C7(-*)	-	
<input type="checkbox"/>	01	101	Tenant Station2	IXG-2C7(-*)	-	
<input type="checkbox"/>	01	101	Video Door Station1	IX-DV,IX-DVF(-*)	-	
<input type="checkbox"/>	01	102	Tenant Station1	IXG-2C7(-*)	-	
<input type="checkbox"/>	01	102	Tenant Station2	IXG-2C7(-*)	-	

Select Station by Type:
All [Select] [Unselect]

Select file type to be uploaded.
[Settings] [Sounds] [Images] [Schedules]

How to upload settings

1. Select the station from which to upload the setting file from "Station List." (Multiple selections allowed.)
 - To select or unselect stations in a batch, choose the type and click **[Select]** or **[Unselect]**.
 - A station can be selected only if "Association Settings" have been configured for the station in Administrator mode.
2. Upload the file.
 - [Settings]**: Upload only the setting file.
 - [Sounds]**: Upload the setting file and audio file for a custom tone.
 - [Images]** (IXG-DM7(-*) only): Download the setting file and the image file for Welcome Screen Settings.
 - [Schedules]** (IX-MV7-*, IXG-MK only): Select and upload transfer and other schedule setting files. Refer to ["How to upload schedules \(→page 61\)"](#).
3. If **[Settings]**, **[Sounds]**, or **[Images]** was clicked, click **[OK]**.
 - Click **[Cancel]** to return to the "Setting File Upload" screen without uploading.

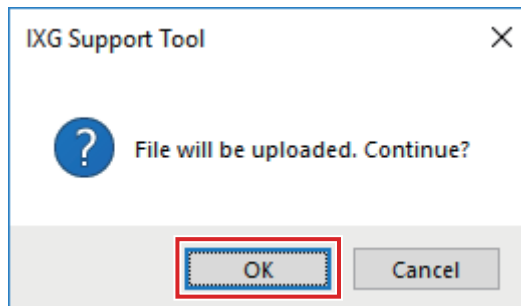

4. Click **[OK]**.
 - The file upload result is displayed in "Station List" - "Status."
 - In Process: The file is in the process of uploading.
 - Success: Upload is completed.
 - Failed: Upload failed. Try uploading again.
 - Unavailable: This is displayed when a file that cannot be uploaded was selected in Step 2.

How to upload schedules

In Step 2 of "[How to upload settings \(→page 60\)](#)", if **[Schedules]** is clicked, the following screen is displayed.

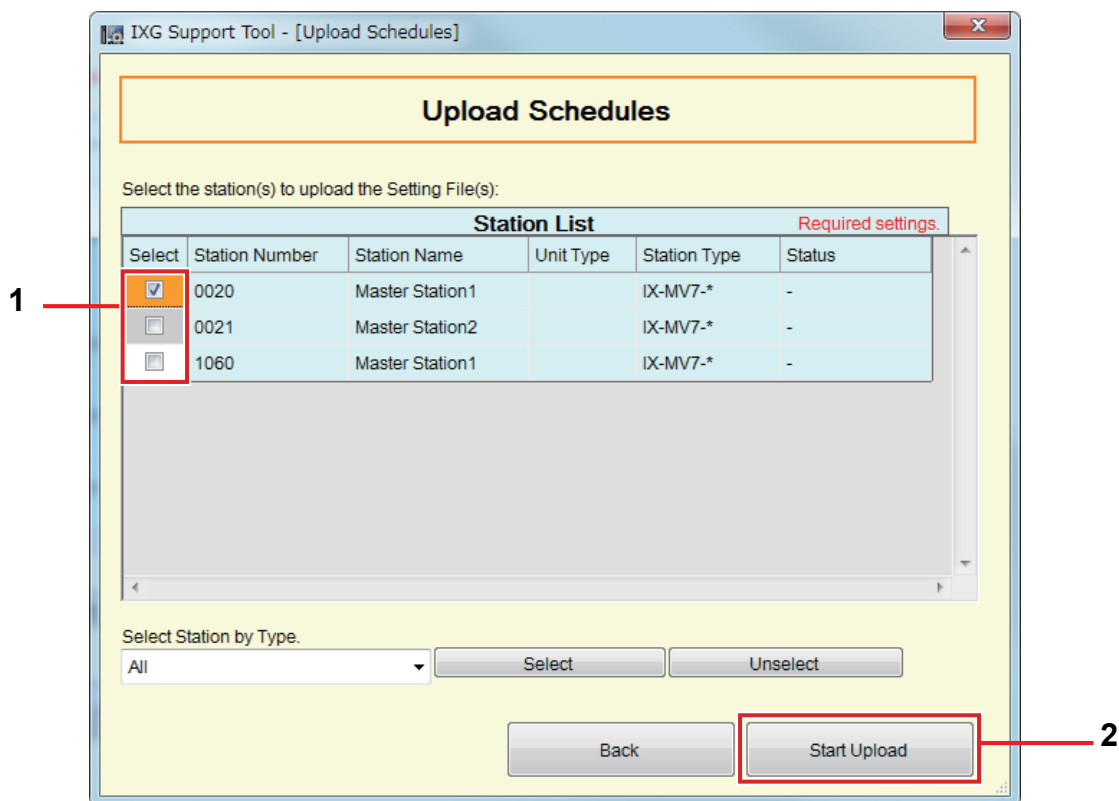

1. Select the station from which to upload the schedule file, from the station list. (Multiple selections allowed.)
 - To select or unselect stations in a batch, choose the station type and click **[Select]** or **[Unselect]**.
2. Click **[Start Upload]**.
3. Click **[OK]**.
 - Click **[Cancel]** to return to the "Upload Schedules" screen without uploading.

2.4 Download Log File

Obtain (download) log files from IXG-DM7(-*), IXG-MK, IXG-2C7(-*), IXGW-LC, or IXGW-GW.

Downloading can be performed only if "Association Settings" have been configured in advance in Administrator mode.

Select "Connection" - "Download Log File ." The "Download Log" screen will be displayed.

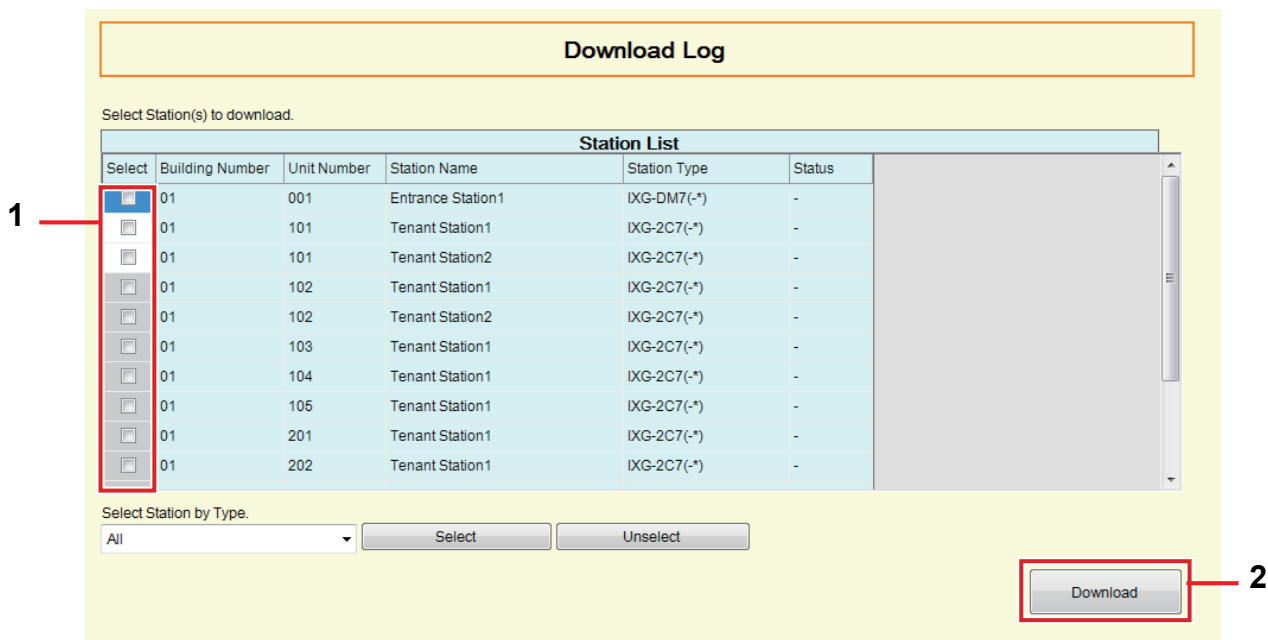

How to obtain log files

1. Select the station from which to download the log files from "Station List." (Multiple selections allowed.)
 - To select or unselect stations in a batch, choose the station type and click **[Select]** or **[Unselect]**.
 - A station can be selected only if "Association Settings" have been configured for the station in Administrator mode.
2. Click **[Download]**.
3. Click **[OK]**.
 - Click **[Cancel]** to return to the "Download Log" screen without downloading.
4. Select the folder where the log files are saved and click **[OK]**.
 - A folder with the name "Station Number_Date_log.gz" will be created in the specified directory, and the log files will be saved inside as hidden files.
 - Click **[Cancel]** to return to the "Download Log" screen without saving log files.
 - The file download result is displayed in "Station List" - "Status."
 - In Process: The file is in the process of downloading.
 - Success: Download is completed.
 - Failed: Download failed. Try downloading again.
5. Click **[OK]**.

3. App Integration

If the "App" was registered in [“Units / Stations \(→page 78\)”](#), registration on IXG Cloud Server is necessary. Create an IXG Cloud Server account and log in.

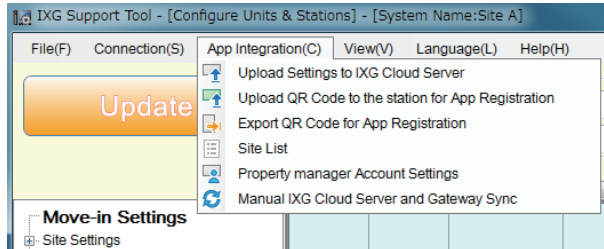

Configure the "IXG Cloud Server ID" and "Password" settings in Administrator mode. An email notification containing the details of the "IXG Cloud Server ID" and "Password" settings configured in Administrator mode is sent.

When logging in for the first time, enter the "ID" and "Password" that are provided in the email, and then follow the on-screen instructions to change the password.

3.1 Upload Settings to IXG Cloud Server

If "App" was registered in "[Units / Stations \(→page 78\)](#)", the following setting data configured in IXG Support Tool will need to be uploaded to IXG Cloud Server.

- Unit Name
- Station Name
- Station List
- Mobile App List

3.1.1 Uploading an existing site to the IXG Cloud Server

If the following settings were changed in IXG Support Tool, upload the changes to the IXG Cloud Server.

- Unit Name "[Units / Stations \(→page 78\)](#)"
- Station Name "[Identification \(→page 81\)](#)"
- Station List "[Station List \(→page 83\)](#)"
- Mobile App List "[Mobile App List \(→page 86\)](#)"

Select "App Integration" - "Upload Settings to IXG Cloud Server." The "IXG Cloud Server Login" screen will be displayed.



The screenshot shows a dialog box titled "IXG Support Tool - [IXG Cloud Server Login]". The dialog has a yellow background and a blue border. At the top, there is a title bar with a close button (X). Below the title bar, the text "IXG Cloud Server Login" is displayed in a large, bold, black font. Underneath, there are two input fields: "IXG Cloud Server ID" and "Password". Below the "Password" field, there is a blue hyperlink that says "*Forgot password?". At the bottom of the dialog, there are two buttons: "Login" and "Cancel".

How to apply settings to the IXG Cloud Server

1. Enter the "IXG Cloud Server ID" and "Password."
2. Click **[Login]**.
 - Login to the IXG Cloud Server.
 - Click **[Cancel]** to exit.

3. Click **[Upload]**.
- Click **[Cancel]** to exit.



4. Click **[Agree]**.
- The changes are applied to IXG Cloud Server.
 - Click **[Disagree]** to exit.

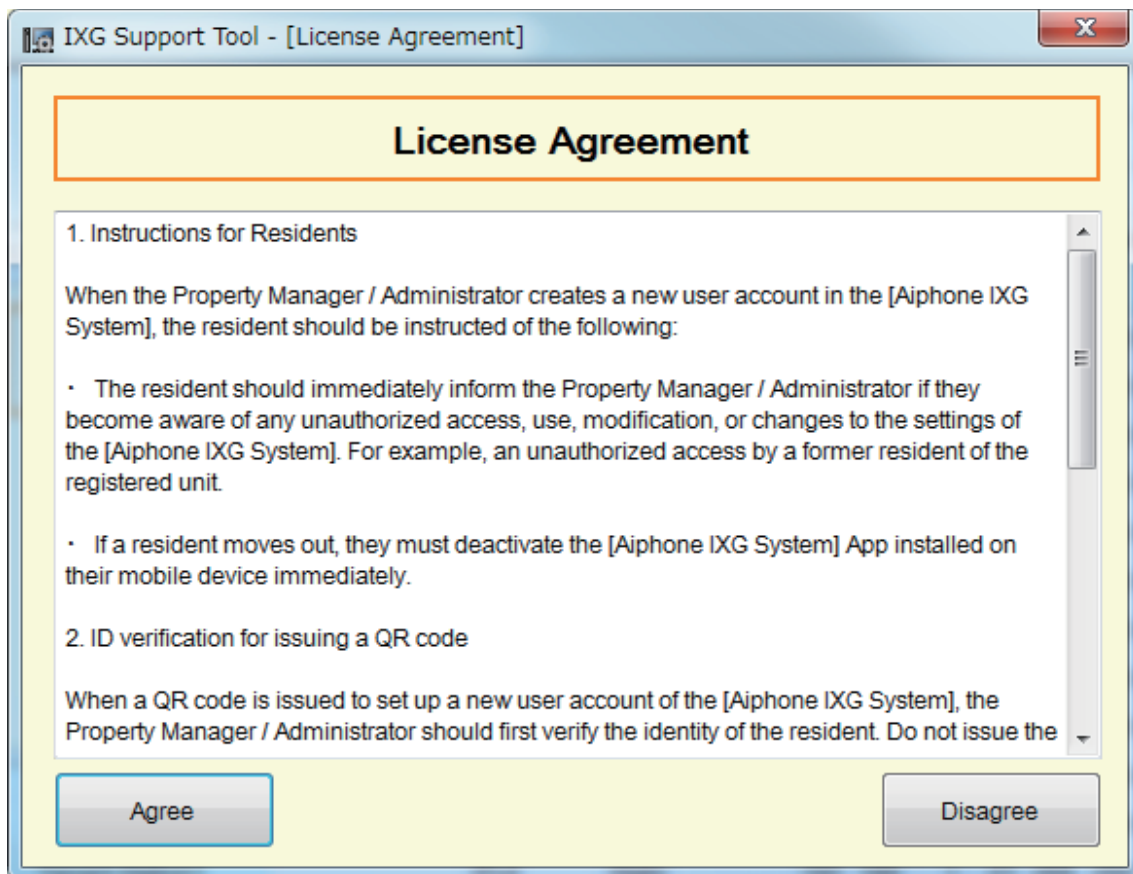

5. Click **[OK]** to send the QR Code for App Registration to the Tenant Station.
 - The QR code will be sent to the Tenant Station. Refer to [“Applying QR Code for App Registration to a station \(→page 67\)”](#) for details.
 - Click **[Cancel]** to exit.

3.2 Applying QR Code for App Registration to a station

After uploading the settings configured with IXG Support Tool in [“Upload Settings to IXG Cloud Server \(→page 64\)”](#), a QR Code for App Registration is sent to the Tenant Station. If there is no Tenant Station in a Residential unit or an Intercom App was registered in a non-Residential unit, refer to [“Export QR Code for App Registration \(→page 68\)”](#). The settings can be applied only if "Association Settings" have been configured in advance in Administrator mode. Click "App Integration" - "Upload QR Code to the station for App Registration." The following screen will be displayed.



The screenshot shows a web interface with a yellow header containing a button labeled "Upload to station(s)". Below the button is a table with the following columns: Select, Building Number, Unit Number, Unit Name, Station Number, Station Name, Status, Available App(s), and Status. The table contains 13 rows of data representing different tenant stations.

Select	Building Number	Unit Number	Unit Name	Station Number	Station Name	Status	Available App(s)	Status
<input checked="" type="checkbox"/>	01	101	Residential101	1010	Tenant Station1	Uploaded	3	Success
<input checked="" type="checkbox"/>	01	101	Residential101	1011	Tenant Station2	Uploaded	3	Success
<input type="checkbox"/>	01	102	Residential102	1020	Tenant Station1	Association Required	3	
<input type="checkbox"/>	01	102	Residential102	1021	Tenant Station2	Association Required	3	
<input type="checkbox"/>	01	103	Residential103	1030	Tenant Station1	Association Required	0	
<input type="checkbox"/>	01	104	Residential104	1040	Tenant Station1	Association Required	0	
<input type="checkbox"/>	01	105	Residential105	1050	Tenant Station1	Association Required	0	
<input type="checkbox"/>	01	201	Residential201	2010	Tenant Station1	Association Required	0	
<input type="checkbox"/>	01	202	Residential202	2020	Tenant Station1	Association Required	0	
<input type="checkbox"/>	01	203	Residential203	2030	Tenant Station1	Association Required	0	
<input type="checkbox"/>	01	204	Residential204	2040	Tenant Station1	Association Required	0	
<input type="checkbox"/>	01	205	Residential205	2050	Tenant Station1	Association Required	0	

How to upload the QR code to the station

1. Select the Tenant Station to send the QR Code for App Registration.
2. Click **[Upload to station(s)]**.
 - The result will be displayed in "Status."
 - In Process: The QR code is being sent.
 - Success: The QR code has been applied.
 - Failed: The QR code has not been applied. Try again.
3. Click **[OK]**.

3.3 Export QR Code for App Registration

Once the settings files have been uploaded to the IXG Cloud Server in ["Upload Settings to IXG Cloud Server" \(→page 64\)](#) generate a PDF file with QR code. A QR code for App Registration can be sent to the Tenant Station if a Tenant Station is registered in the Residential Unit. Refer to ["Applying QR Code for App Registration to a station" \(→page 67\)](#).

The settings can be applied only if "Association Settings" have been configured in advance in Administrator mode. Click "App Integration" - "Export QR Code for App Registration." The following screen will be displayed.

Export QR Code for App Registration

Select	Building Number	Unit Number	Unit Name	Registered Master Station(s)	Available App(s)
<input type="checkbox"/>	01	001	Entrance001	0	0
<input type="checkbox"/>	01	002	Inside Area 002	0	0
<input type="checkbox"/>	01	003	Outside Area 003	0	0
<input type="checkbox"/>	01	101	Residential101	2	3
<input type="checkbox"/>	01	102	Residential102	2	3
<input type="checkbox"/>	01	103	Residential103	1	0
<input type="checkbox"/>	01	104	Residential104	1	0
<input type="checkbox"/>	01	105	Residential105	1	0
<input type="checkbox"/>	01	106	Commercial106	0	1
<input type="checkbox"/>	01	201	Residential201	1	0
<input type="checkbox"/>	01	202	Residential202	1	0
<input type="checkbox"/>	01	203	Residential203	1	0
<input type="checkbox"/>	01	204	Residential204	1	0
<input type="checkbox"/>	01	205	Residential205	1	0
<input type="checkbox"/>	01	206	Guard206	0	1

How to export the QR Code for App Registration

1. Select the unit to register a Mobile App.
2. Click **[Export QR Code for App Registration]**.
3. Specify the save directory and click **[OK]**.
 - A file with the name "(Building Number)_(Unit Number)" will be saved in the specified directory.
4. Click **[OK]**.

3.4 Site List

Check the list of sites that are being managed.

Select "App Integration" - "Site List." The following screen will be displayed.

How to configure Site List Settings

1. Enter the "IXG Cloud Server ID" and "Password."
2. Click **[Login]**.
 - Login to the IXG Cloud Server.
 - Click **[Cancel]** to exit IXG Cloud Server Login.
3. Check the site list.
 - Click **[Close]** to finish configuring the Site List / Property Manager Account Settings.

Site List			
Site ID	Site Name	Property Manager	Email
175	Site A	User4	[redacted]

3.5 Property manager Account Settings

Change the email address and password that are registered for the property manager. Configure this if the registered email address was changed, or to change the password. Select "App Integration" - "Property manager Account Settings." The following screen will be displayed.

How to configure the property manager account settings

1. Enter the "IXG Cloud Server ID" and "Password."
2. Click **[Login]**.
 - Login to the IXG Cloud Server.
 - Click **[Cancel]** to exit.
3. Change the following information if required.
 - Change Email Address: Enter the new email address and click **[Change Email Address]**. (Email: 1-64 alphanumeric characters.)
 - Change Password: Enter the current and new passwords, and then click **[Change Password]**. (The password must be at least 8 alphanumeric characters and include uppercase letters, lowercase letters, and numbers.)
 - Click **[Close]** to finish configuring the property manager account settings.
4. If **[Change Email Address]** was clicked in Step 3, an email containing the Verification Code will be sent to the registered email address. Click **[OK]**.
5. Enter the received "Verification Code" and then click **[Activate]**.
 - Clicking **[Resend]** resends the verification code.
 - Click **[Cancel]** to exit.
6. Click **[OK]**.

3.5.1 Password Recovery

If the password used to login to the IXG Cloud Server was forgotten, a new password can be created. Click "App Integration" - "Upload Settings to IXG Cloud Server," "Site List," or "Property manager Account Settings." The following screen will be displayed.

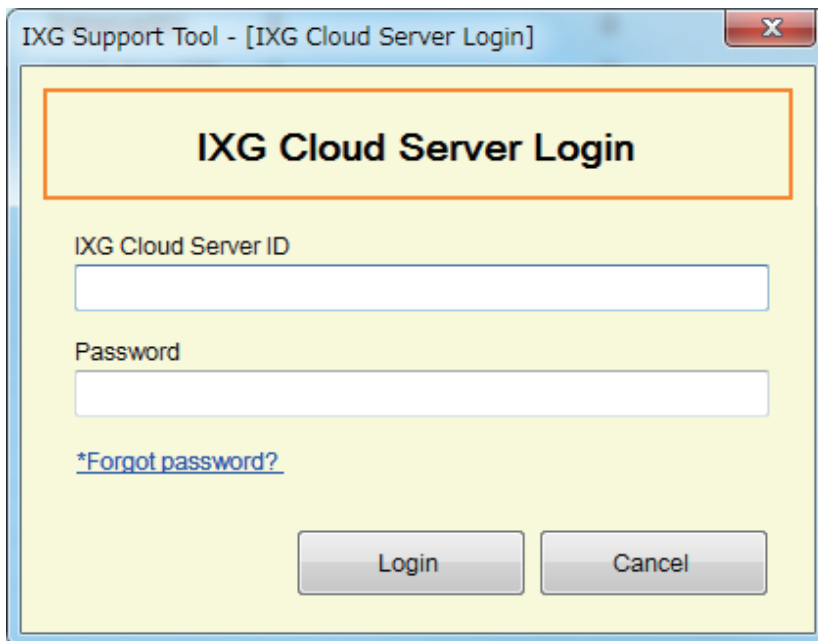

The screenshot shows a dialog box titled "IXG Support Tool - [IXG Cloud Server Login]". The main heading is "IXG Cloud Server Login". Below the heading are two input fields: "IXG Cloud Server ID" and "Password". A blue link labeled "*Forgot password?" is positioned below the password field. At the bottom of the dialog are two buttons: "Login" and "Cancel".

How to create a new password

1. Click [***Forgot password?**].
2. Enter "IXG Cloud Server ID" or "Email," and click [**Send Email**].
 - An email containing the Verification Code will be sent either to the email address associated with the IXG Cloud Server ID or to the email address that was entered.
 - Click [**Cancel**] to exit.

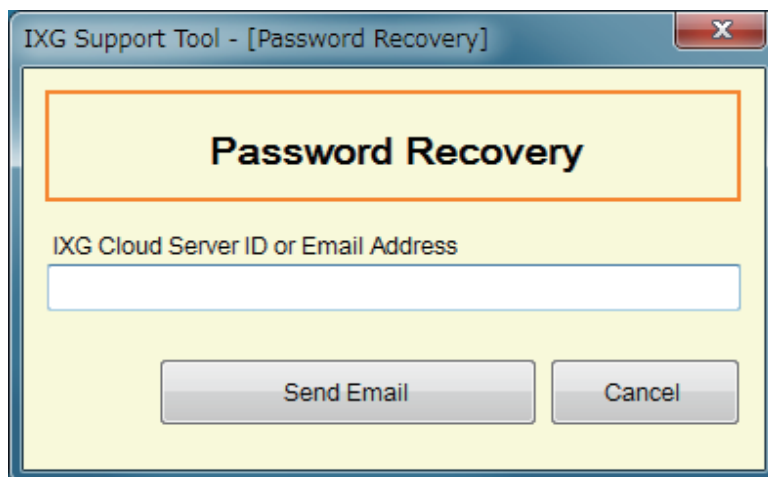

The screenshot shows a dialog box titled "IXG Support Tool - [Password Recovery]". The main heading is "Password Recovery". Below the heading is a single input field labeled "IXG Cloud Server ID or Email Address". At the bottom of the dialog are two buttons: "Send Email" and "Cancel".

Note

- Input the Email Address which is registered in the IXG Cloud Server for the Email Address.

3. Click **[OK]**.

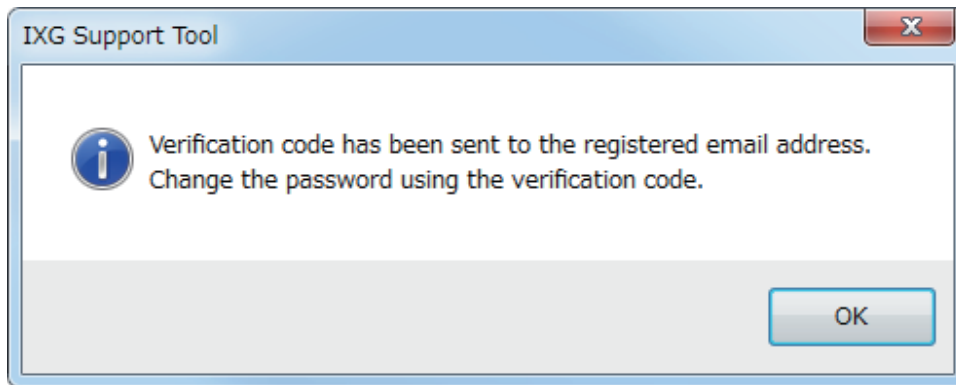

4. Enter the following information.

- Verification Code: Enter the "Verification Code" contained in the email.
- New Password: The password must be at least 8 alphanumeric characters and include uppercase letters, lowercase letters, and numbers.
- Confirm Password: Enter the same password again.

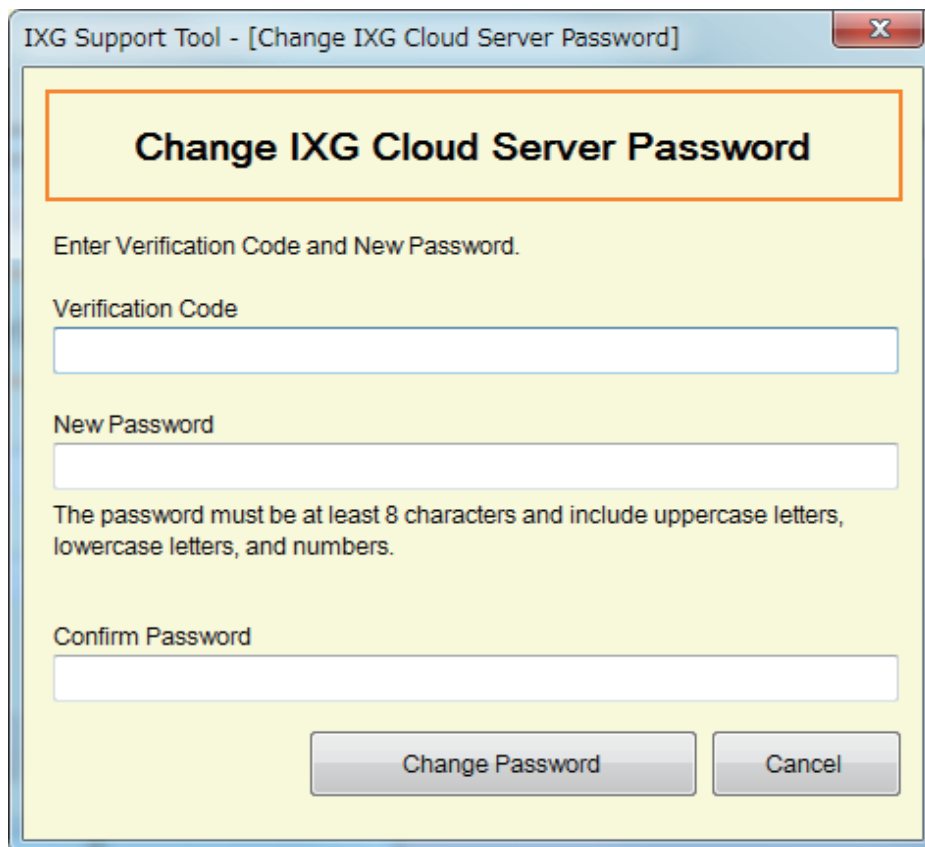

5. Click **[Change Password]**.

- The password will be changed.
- Click **[Cancel]** to exit.

6. Click **[OK]**.

3.6 Manual IXG Cloud Server and Gateway Sync

If the app integration function is not working properly, synchronize the settings of the Gateway Adaptor and the IXG Cloud Server.

! Important

- The Gateway Adaptor can be configured only if "Association Settings" have been configured in Administrator mode, and the PC can communicate with the system.

Click "App Integration" - "Manual IXG Cloud Server and Gateway Sync" to display the following screen.

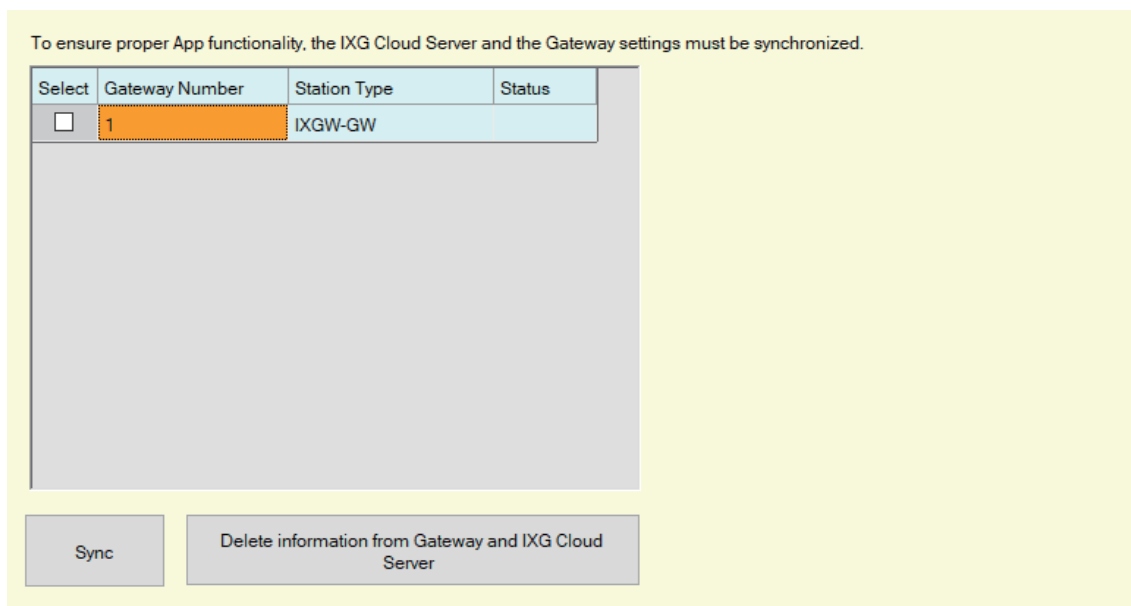

Manual IXG Cloud Server and Gateway Sync

1. Select the Gateway Adaptor to synchronize with the IXG Cloud Server.
2. Click **[Sync]**.
 - The IXG Cloud Server and the Gateway Adaptor will be synchronized.
 - The file synchronization result is displayed in "Status."
 In Process: Currently synchronizing.
 Success: Synchronization successful.
 Failed: Synchronization failed. Try synchronizing again.

How to delete linked information from the Gateway and the IXG Cloud Server

If app integration will no longer be used, delete the gateway information from the IXG Cloud Server and the IXG Cloud Server information from the gateway.

1. Select the Gateway Adaptor for which to delete the link.
2. Click **[Delete information from Gateway and IXG Cloud Server]**.
 - The gateway information is deleted from the IXG Cloud Server, and the IXG Cloud Server information is deleted from the gateway.
 - The result is displayed in "Status."
 In Process: Linked information is being deleted.
 Success: Linked information has been deleted.
 Failed: Linked information has not been deleted, try again.

4. View

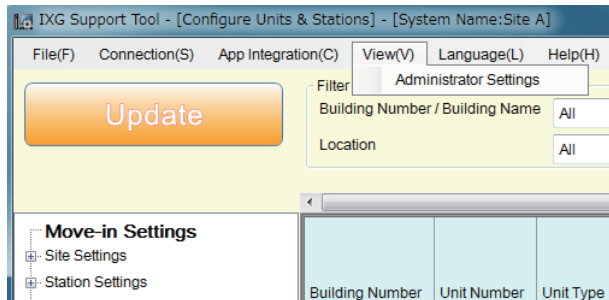

Switch to Administrator Settings (Administrator mode).

In Administrator mode, "Basic" and "Advanced" settings are available.

- Basic: Configure only the following settings.

- Site Information
- Building Information
- Units / Stations
- Gateway Registration
- Gateway Selection
- Identification
- ID / Password
- IP Address
- DNS
- NTP

- Advanced: Perform detailed configuration for all functions.

For information on Administrator mode, refer to the separate "IXX Support Tool Setting Manual: Administrator Mode."

5. Language

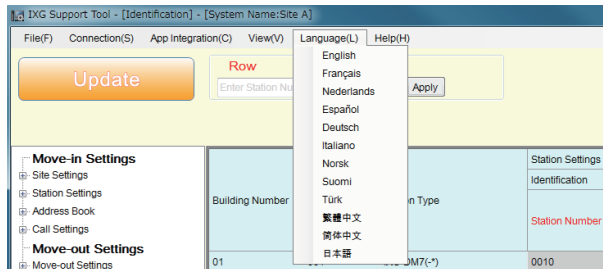

Set the language of following items.

- The display content of the IXG Support Tool.
- The language used to enter setting data (Units / Stations, etc.)
- The content of the email message.

! Important

- The language used on each station can be changed on the Settings screen of each station.
- If the language (configured on the station main unit) displayed on the screen for IXG-2C7(-*), IX-MV7-*, IXG-MK, IXG-DM7(-*), or Intercom App is different from the language set with "Language" the characters may appear incorrectly. To avoid this, enter information in the setting data using alphabetical characters only.

6. Help

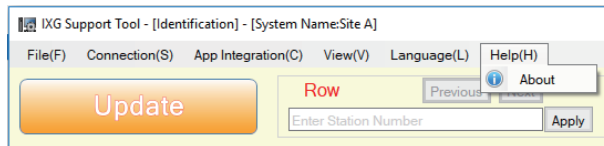

6.1 About

Select "Help" - "About." The "About" screen will be displayed.

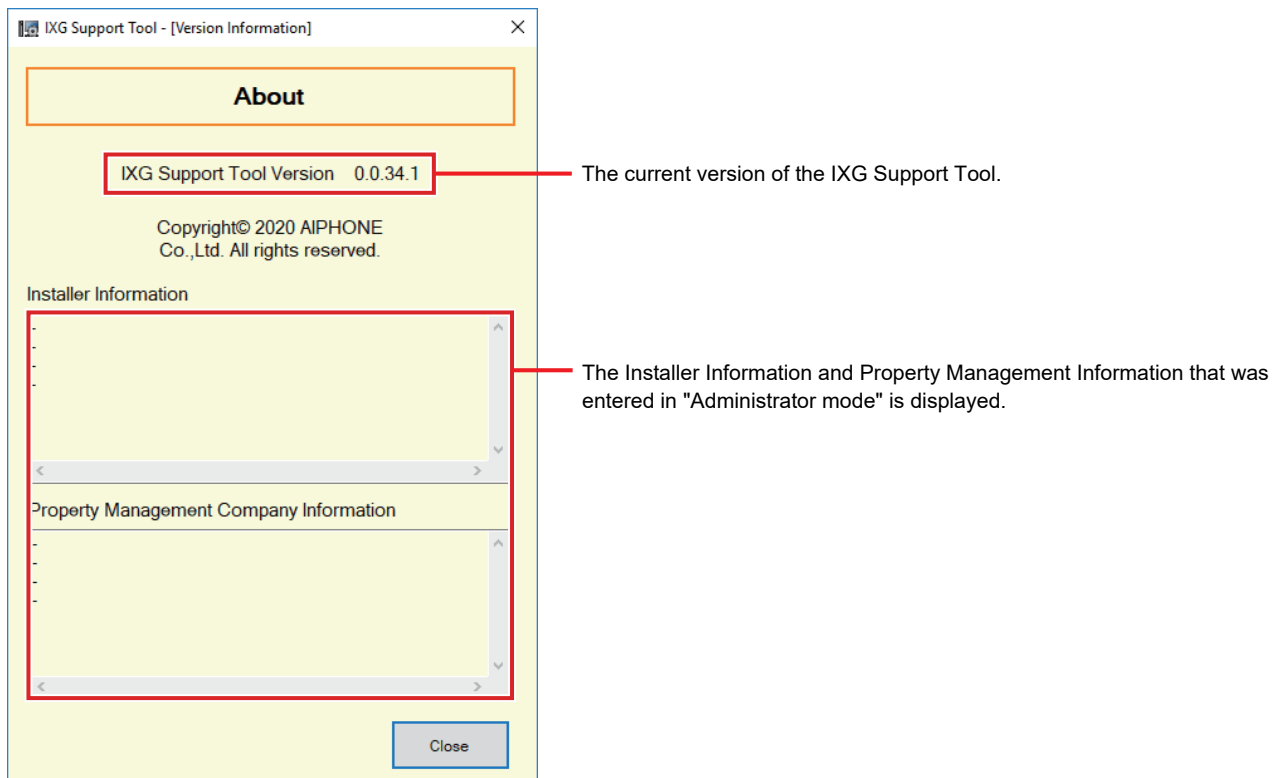

Click **[Close]** to close the "About" screen.

System Settings

Important

- Depending on the display language of the Master Station (IXG-2C7(-*), IX-MV7-*, IXG-MK, IXG-DM7(-*), or Intercom App), the settings may appear incorrectly.
- The symbols indicate the following:
 - ◆: Be sure to enter a setting value. Use the default values, unless a change is necessary.

1. Site Information (Move-in Settings)

1.1 Units / Stations

Configure common area and private area information.

Up to 9,999 units can be registered.

Up to 9,999 IXG and IX stations can be registered. Up to 9,999 Mobile Apps can be registered.

Register IXG and IX stations in Administrator mode.

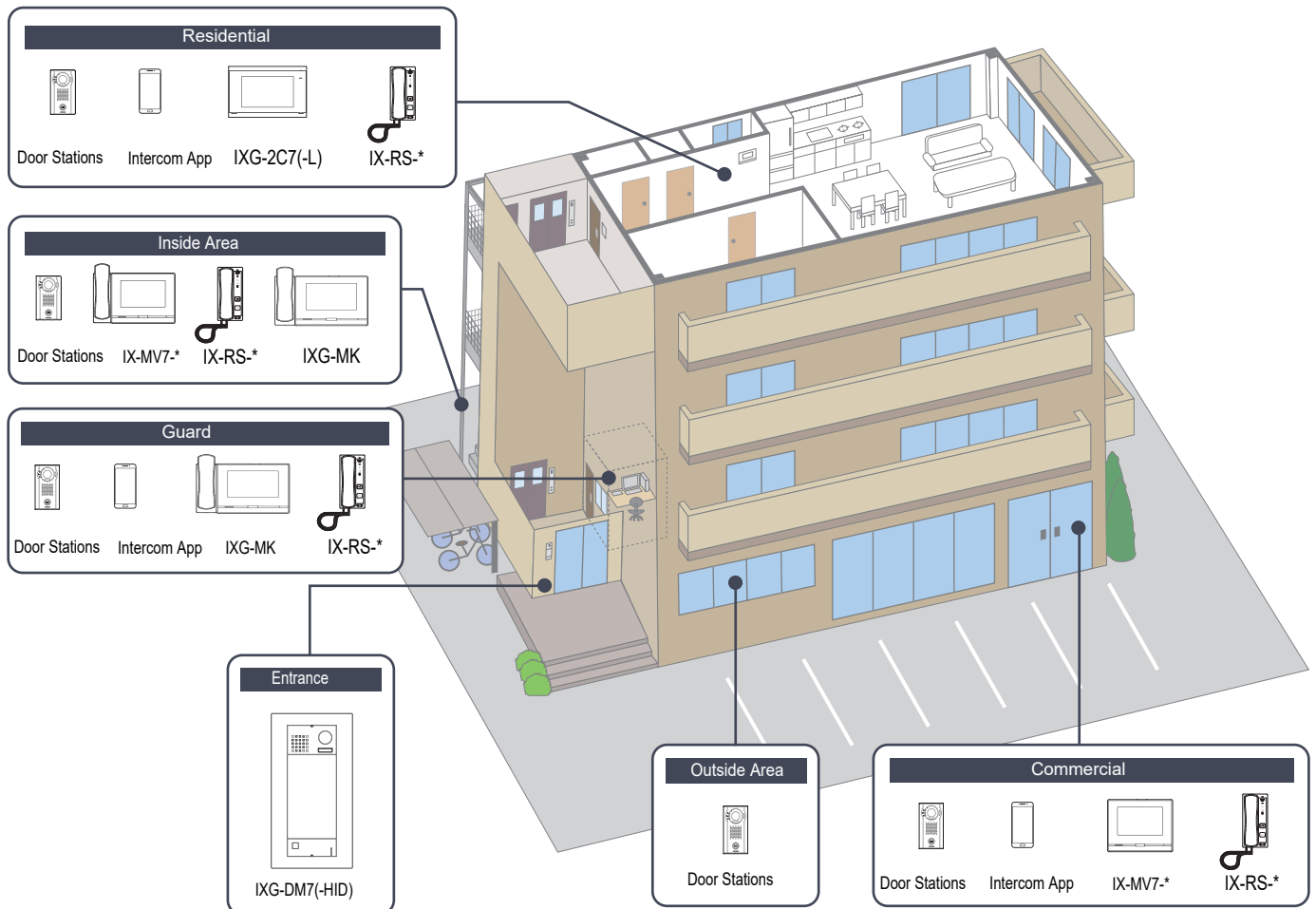

■ First Name (Residential only)

Description	<p>Enter the first name.</p> <p>The First Name will be displayed on the selection button of the Search by List Screen on the Entrance Station.</p> <p>This is also used to search for a destination on the Entrance Station.</p>
Settings	<p>Alphanumeric characters, alphanumeric spaces, symbols ("!\$%()./:;?@_+) 1-16 characters</p> <p>If information other than the above are input, the input information will become blank or the characters may appear incorrectly when the display language was changed on the Entrance Station.</p>

■ Last Name (Residential only)

Description	<p>Enter the last name.</p> <p>The Last Name will be displayed on the selection button of the Search by List Screen on the Entrance Station.</p> <p>This is also used to search for a destination on the Entrance Station.</p>
Settings	<p>Alphanumeric characters, alphanumeric spaces, symbols ("!\$%()./:;?@_+) 1-16 characters</p> <p>If information other than the above are input, the input information will become blank or the characters may appear incorrectly when the display language was changed on the Entrance Station.</p>

 **Note**

- Only alphanumeric characters can be entered on the Search by Name Screen for an Entrance Station, so enter only alphanumeric characters for the "First Name" and "Last Name" when using "Search by Name" with an Entrance Station.

■ App (Guard, Commercial, Residential only)

Description	<p>Configure the station type of the app to register to Guard, Commercial, or Residential Unit.</p> <p>Up to 8 Mobile Apps can be registered in each unit.</p> <p>Click [Select] and select the app station type.</p>
Settings	<p>Intercom App, Delete</p>

2. Station Information (Move-in Settings)

2.1 Identification

Configure the Station Number and Station Name of the station to register in the system.

Move row

Up to 50 station number rows can be displayed at a time. Switch the screen as follows.

[Previous]: Display the previous 50 rows.

[Next]: Display the next 50 rows.

[Apply]: Enter the station number and click **[Apply]** to move the cursor to the row of the station number that was entered.

Building Number	Unit Number	Station Type	Station Settings	
			Station Number	Station Name
01	001	IXG-DM7(-*)	0010	Entrance Station1
01	002	IX-MV7-*	0020	Master Station1
01	002	IX-MV7-*	0021	Master Station2
01	002	IX-DV,IX-DVF(-*)	0022	Video Door Station1
01	002	IX-DV,IX-DVF(-*)	0023	Video Door Station1

! Important

- Always set "[Language \(→page 75\)](#)" before setting "Identification."
- Enter using the language set in "[Language \(→page 75\)](#)". However, if the language (configured on the station main unit) displayed on the screen for IXG-2C7(-*), IXG-MK, IX-MV7-*, IXG-DM7(-*), or Intercom App is different from the language set with "[Language \(→page 75\)](#)", the characters displayed on the station screen may appear incorrectly. To avoid this, enter information using alphabetical characters only.

■ Station Number ◆

Compatible type	<input type="checkbox"/> IXG-2C7(-*) <input type="checkbox"/> IXG-MK <input type="checkbox"/> IX-MV7-* <input type="checkbox"/> IXG-DM7(-*) <input type="checkbox"/> IX-DA <input type="checkbox"/> IX-BA <input type="checkbox"/> IX-DV, IX-DVF(-*) <input type="checkbox"/> IX-SSA(-*) <input type="checkbox"/> IX-EA, IX-EAU <input type="checkbox"/> IX-FA <input type="checkbox"/> IXGW-LC <input type="checkbox"/> IXGW-GW <input checked="" type="checkbox"/> Intercom App <input type="checkbox"/> IX-SS-2G <input type="checkbox"/> IX-RS-*
Description	Set the station number. Ensure that it does not overlap with the unit number or another station number. The set station number will be shown on the destination station when placing a call or when paging is performed.
Settings	3-24 digits
Default value	Single Building System: Unit Number+sequence number starting from 000 for each unit type Multiple Building System: Building Number+Unit Number+sequence number starting from 000 for each unit type

■ Station Name ◆

Compatible type	<input checked="" type="checkbox"/> IXG-2C7(-*) <input checked="" type="checkbox"/> IXG-MK <input checked="" type="checkbox"/> IX-MV7-* <input checked="" type="checkbox"/> IXG-DM7(-*) <input checked="" type="checkbox"/> IX-DA <input checked="" type="checkbox"/> IX-BA <input checked="" type="checkbox"/> IX-DV, IX-DVF(-*) <input checked="" type="checkbox"/> IX-SSA(-*) <input checked="" type="checkbox"/> IX-EA, IX-EAU <input type="checkbox"/> IX-FA <input checked="" type="checkbox"/> IXGW-LC <input checked="" type="checkbox"/> IXGW-GW <input checked="" type="checkbox"/> Intercom App <input checked="" type="checkbox"/> IX-SS-2G <input checked="" type="checkbox"/> IX-RS-*
Description	Set the station name. The set station name will be shown on the destination station when placing a call.
Settings	1-24 alphanumeric characters
Default value	<ul style="list-style-type: none"> • Intercom App: Intercom App (number) • Stations other than Intercom App: -

3. System Information (Move-in Settings)

3.1 Station List

Compatible type	<input checked="" type="checkbox"/> IXG-2C7(-*) <input checked="" type="checkbox"/> IXG-MK <input checked="" type="checkbox"/> IX-MV7-* <input checked="" type="checkbox"/> IXG-DM7(-*) <input type="checkbox"/> IX-DA <input type="checkbox"/> IX-BA <input type="checkbox"/> IX-DV, IX-DVF(-*) <input type="checkbox"/> IX-SSA(-*) <input type="checkbox"/> IX-EA, IX-EAU <input type="checkbox"/> IX-FA <input type="checkbox"/> IXGW-LC <input type="checkbox"/> IXGW-GW <input checked="" type="checkbox"/> Intercom App <input type="checkbox"/> IX-SS-2G <input type="checkbox"/> IX-RS-*
-----------------	--

Configure the address book for IX-MV7-*, IXG-MK, IXG-2C7(-*), IXG-DM7(-*), or Intercom App.

Up to 500 stations can be registered only on the IXG-2C7(-*).

The number of stations which can be registered on the IX-MV7-* is the number of stations registered on the [“Station List \(→page 83\)”](#) plus the number of units registered on the [“Mobile App List \(→page 86\)”](#) for a maximum total of 9,998.

Calling, paging, monitoring (IXG-DM7(-*) and Door Stations only), line supervision, and device checking (IX Station only) can be performed by IX-MV7-* for stations registered in the Address Book.

Calling, paging, and monitoring (IXG-DM7(-*) and Door Stations only) can be performed by IXG-MK for stations registered in the Address Book.

Calling (except for IXG-DM7(-*), Door Stations) and monitoring (IXG-DM7(-*) and Door Stations only) can be performed by IXG-2C7(-*) for stations registered in the Address Book.

Calling can be performed by IXG-DM7(-*) for stations registered in the Address Book.

Monitoring can be performed by Intercom App for stations registered in the Address Book.

Monitoring can be performed for network cameras.

Move row

Up to 50 station number rows can be displayed at a time. Switch the screen as follows.

[Previous]: Display the previous 50 rows.

[Next]: Display the next 50 rows.

[Apply]: Enter the station number and click **[Apply]** to move the cursor to the row of the station number that was entered.

Move column

Up to 50 station number columns can be displayed at a time. Switch the screen as follows.

[Previous]: Display the previous 50 columns.

[Next]: Display the next 50 columns.

[Apply]: Enter the station number and click **[Apply]** to move the cursor to the column of the station number that was entered.

The screenshot shows two navigation panels at the top: 'Row' and 'Column'. Each panel has 'Previous', 'Next', and 'Apply' buttons, and a text input field for 'Enter Station Number'. Below these is a table with columns for 'Building Number', 'Unit Number', and 'Station Name'. To the right is a 'System Information' table with columns for 'Entrance Station 1 / IXG-DM7(-*)', 'Master Station 1 / IX-MV7-*', 'Video Door Station 1 / IX-DV/IX-DVF(-*)', and 'Indset Sub Station 2 / IX-F'. The 'System Information' table has sub-columns for 'Select', 'Network Camera', and 'Ir Release But'. Red boxes and arrows highlight the 'Row' and 'Column' controls, and specific cells in the 'System Information' table, including a dropdown menu and a 'Network Camera' entry.

List of IX-MV7-*, IXG-MK, IXG-2C7(-*), IXG-DM7(-*), Intercom App in setting data

If a network camera has not been registered in "[Network Camera List \(→page 88\)](#)", this will not be shown.

List of stations that can be registered to the Address Book

! Important

- A station cannot be registered to the Address Book unless "IP Address" has been configured for the station in Administrator mode.

How to create a Station List

1. Search for the stations for which the Address Book will be set up from the "list of IX-MV7-*, IXG-MK, IXG-2C7(-*), IXG-DM7(-*), and Intercom App in setting data."
2. Search for the station to be registered in the Address Book using "list of stations that can be registered to the Address Book."

3. Click the cells ("Select," "Network Camera," and "Door Release Button") that correspond to Steps 1 and 2.

- Select: The station for which "✓" was selected will be registered in the Address Book.
- Network Camera (IX-MV7-*, IXG-MK, and IXG-2C7(-*) only): Click **[Network Camera Selection]** to select the network camera to associate. Network cameras configured in "[Network Camera List \(→page 88\)](#)" may be selected. The number of the selected network camera is displayed.

If a network camera is associated with a station, the video from the network camera will be displayed when placing a call, during a communication, or when monitoring.

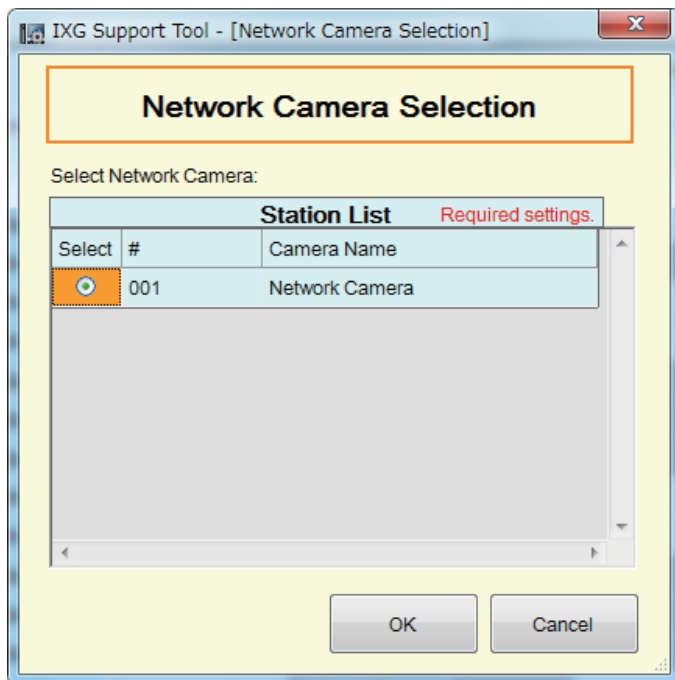

- Door Release Button (Intercom App only): Set whether to display the Door Release button on the station screen in order to release the door.
 - Disable: Do not display the Door Release button on the station screen.
 - Display 1 Only: Display only Door Release button 1 on the station screen.
 - Display 1 and 2: Display Door Release button 1 and Door Release button 2 on the station screen.

4. After configuration is complete, click **[Update]**.

5. Click **[OK]**.

3.2 Mobile App List

Compatible type	<input checked="" type="checkbox"/> IXG-2C7(-*) <input checked="" type="checkbox"/> IXG-MK <input checked="" type="checkbox"/> IX-MV7-* <input checked="" type="checkbox"/> IXG-DM7(-*) <input type="checkbox"/> IX-DA <input type="checkbox"/> IX-BA <input type="checkbox"/> IX-DV, IX-DVF(-*) <input type="checkbox"/> IX-SSA(-*) <input type="checkbox"/> IX-EA, IX-EAU <input type="checkbox"/> IX-FA <input type="checkbox"/> IXGW-LC <input type="checkbox"/> IXGW-GW <input type="checkbox"/> Intercom App <input type="checkbox"/> IX-SS-2G <input type="checkbox"/> IX-RS-*
-----------------	---

Register the unit containing the Mobile App to call in the Address Book.
All Mobile Apps in a registered unit can be called at once.

The number of stations which can be registered on the IX-MV7-* is the number of stations registered on the [“Station List \(→page 83\)”](#) plus the number of units registered on the [“Mobile App List \(→page 86\)”](#) for a maximum total of 9,998.

Move row

Up to 50 station number rows can be displayed at a time. Switch the screen as follows.

[Previous]: Display the previous 50 rows.

[Next]: Display the next 50 rows.

[Apply]: Enter the station number and click **[Apply]** to move the cursor to the row of the station number that was entered.

Move column

Up to 50 station number columns can be displayed at a time. Switch the screen as follows.

[Previous]: Display the previous 50 columns.

[Next]: Display the next 50 columns.

[Building Number]: Select the building.

[Apply]: Select the building number and enter the unit number and click **[Apply]** to move the cursor to the column of the unit number that was entered.

The screenshot shows the 'Mobile App List' interface. At the top, there are two navigation panels: 'Row' and 'Column'. The 'Row' panel has 'Previous', 'Next', and 'Apply' buttons, along with an input field for 'Enter Station Number'. The 'Column' panel has 'Previous', 'Next', and 'Apply' buttons, along with a 'Building Number' dropdown and an 'Enter Unit Number' input field. Below these panels is a table with columns for 'Building Number', 'Unit Number', and 'Station Name'. The table contains several rows of data, including 'Entrance Station1', 'Master Station1', 'Master Station2', and 'Tenant Station1/2'. To the right of the table is a 'System Information' panel with a 'Required settings.' label. Below the table, there are two red boxes with arrows pointing to specific cells: box 1 points to a cell in the 'Station Name' column, and box 2 points to a cell in the 'Unit Number' column. Box 3 points to a cell in the 'Station Name' column.

List of IXG-MK, IX-MV7-*, IXG-2C7(-*), and IXG-DM7(-*) in setting data

List of units that can be registered to the Address Book

Mobile App List

1. Search for the stations for which the Address Book will be set up from the "list of IXG-MK, IX-MV7-*, IXG-2C7(-*), and IXG-DM7(-*) in setting data."
2. Search for the unit to be registered in the Address Book using "list of units that can be registered to the Address Book."
3. Click the cell that corresponds to Steps 1 and 2.
 - Select: The unit for which "✓" was selected will be registered in the Address Book.
4. After configuration is complete, click **[Update]**.

5. Click **[OK]**.

3.3 Network Camera List

IX-MV7-*, IXG-MK, and IXG-2C7(-*) support ONVIF Profile S and RTSP.

Video and audio captured by a 3rd party network camera and microphone can be monitored on the IX-MV7-*, IXG-MK, or IXG-2C7(-*) screen.

Register the network camera in the Address Book. Up to 500 network cameras can be registered.

Configure "Network Camera Integration" to configure event notification-related settings for the network camera in Administrator mode.

Resolution of network cameras capable of displaying video	Resolution of network cameras capable of recording video
<ul style="list-style-type: none"> IX-MV7-*, IXG-MK: SXGA or lower IXG-2C7(-*): HD or lower (However, set to 5 fps or lower if larger than WVGA.) 	<ul style="list-style-type: none"> IX-MV7-*, IXG-MK: QVGA, VGA, WVGA, HD, SXVGA IXG-2C7(-*): QVGA, VGA, WVGA, HD

Move row
Up to 50 station number rows can be displayed at a time. Switch the screen as follows.
[Previous]: Display the previous 50 rows.
[Next]: Display the next 50 rows.
[Apply]: Enter the station number and click **[Apply]** to move the cursor to the row of the station number that was entered.

Move column
Up to 50 station number columns can be displayed at a time. Switch the screen as follows.
[Previous]: Display the previous 50 columns.
[Next]: Display the next 50 columns.
[Apply]: Enter the station number and click **[Apply]** to move the cursor to the column of the station number that was entered.

List of network cameras that can be registered to the Address Book

["Network Camera Registry \(→page 89\)"](#)

List of IX-MV7-*, IXG-MK, and IXG-2C7(-*) in setting data

If no network camera is registered, this will not be shown.

How to create a Network Camera List

1. Register the network camera in ["Network Camera Registry \(→page 89\)"](#).
2. Search for the stations for which the Address Book will be set up from the "list of IX-MV7-*, IXG-MK, and IXG-2C7(-*) in setting data."

3. Identify the network camera to be registered in the Address Book using "List of network cameras that can be registered to the Address Book."
4. Click the cells ("Select" and "Audio Monitoring") that correspond to Steps 2 and 3.
 - Select: Register network cameras with "✓" selected to the Address Book.
 - Audio Monitoring: Configure whether to allow monitoring of network camera audio from the station.
5. After configuration is complete, click **[Update]**.
6. Click **[OK]**.

3.3.1 Network Camera Registry

Click **[Open Network Camera Registry]**. The following screen is displayed.

["How to register a new network camera \(→page 91\)"](#)

Select the network camera(s) to be deleted (multiple selections allowed), and click to delete.

Station Settings		Network Settings			Function Settings		Required settings
Select	#	Camera Name	Hostname	IP Address (IPv4)	IP Address (IPv6)	ID	Password
<input checked="" type="checkbox"/>	001	XXXXXXXXXX		192.168.1.200		001	*****

If no network camera is registered, this will not be shown.

! Important

- Network camera registration can be performed only if "Association Settings" have been configured in Administrator mode on at least one IX-MV7-*, IXG-MK, or IXG-2C7(-*), and the PC can communicate with the system. (This is because, when registering a network camera, the network camera is searched through IX-MV7-*, IXG-MK, or IXG-2C7(-*).)
- Even if the network camera unit settings (resolution, etc.) are changed after uploading the settings to stations (IXG-2C7(-*), IX-MV7-*, IXG-MK) which display network camera video with the IXG Support Tool, the settings are not updated on the stations. Because the network camera information on the station must be erased one time, follow the steps below.
 1. Delete the reconfigured network camera in the "Network Camera List."
 2. With the target network camera in an unregistered state, upload the settings to the station. (The network camera information will disappear on the station side)
 3. Register the target network camera from the "Network Camera List" once more and upload the settings to the station.

■ Camera Name ◆

Description	Set the Network Camera Name.
Settings	1-24 alphanumeric characters
Default value	-

■ Hostname

Description	Set the hostname. When setting the hostname, configure the "DNS" settings in Administrator mode.
Settings	1-64 alphanumeric characters
Default value	-

■ IP Address (IPv4)◆

Description	Set the IPv4 address for Network camera.
Settings	1.0.0.1-223.255.255.254
Default value	-

■ IP Address (IPv6)◆

Description	Set the IPv6 address for Network camera.
Settings	::FF:0-FE:FF:FFFF:FFFF:FFFF:FFFF:FFFF:FFFF
Default value	-

■ ID◆

Description	Enter ID of the network camera.
Settings	1-32 alphanumeric characters
Default value	-

■ Password◆

Description	Enter Password of the network camera.
Settings	1-32 alphanumeric characters
Default value	-



Note

- "Password" is displayed as "*****" in the Settings screen.

How to register a new network camera

Registration cannot be performed if the PC is not connected to the same network as the network camera.

Click **[Add Camera]** to search for a network camera. (Searching may take several minutes.)

When searching is complete, the "Network Camera Selection" screen is displayed, and the network cameras connected to the network are displayed in the "Network Camera Search List."

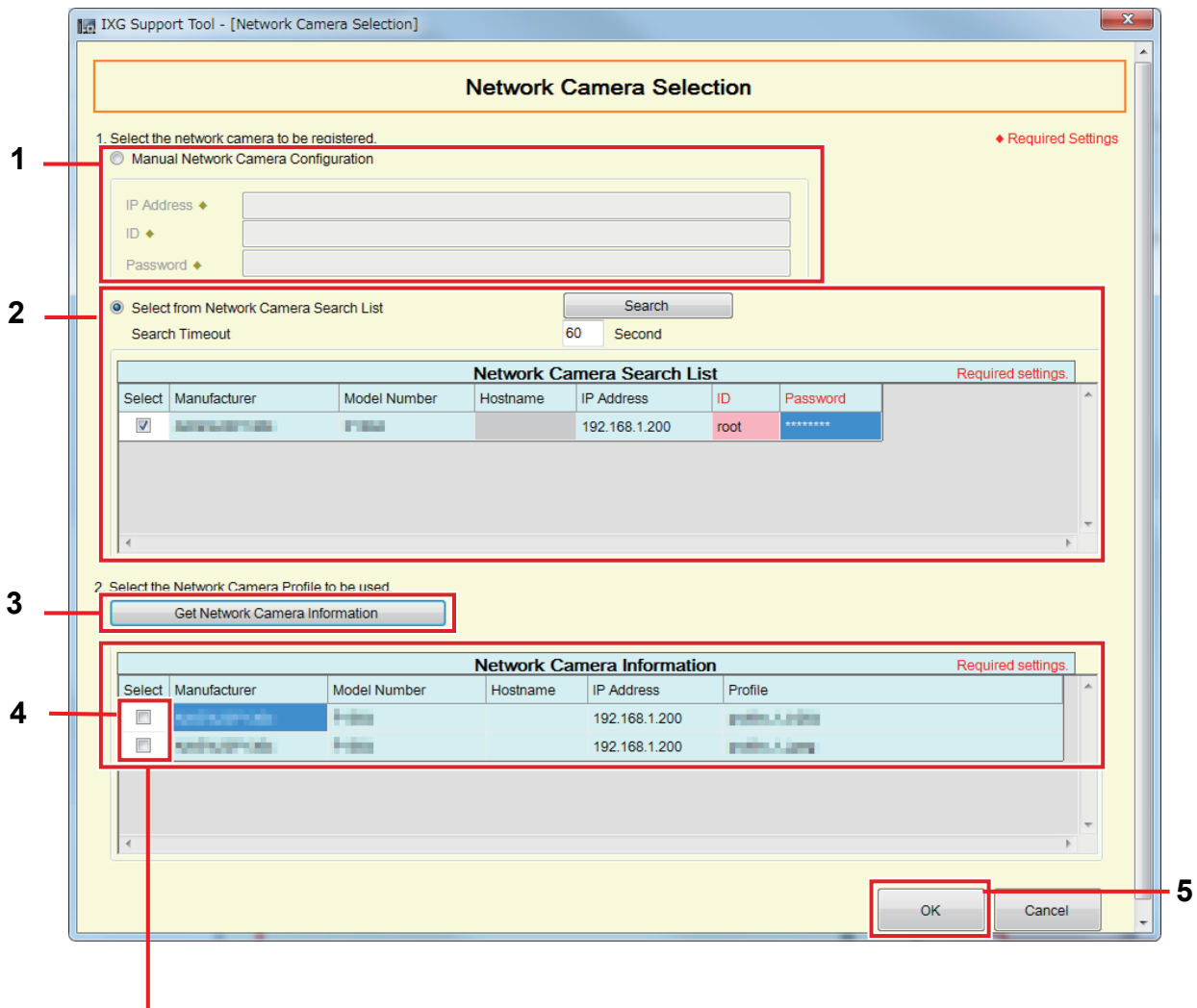

If the video profile cannot be obtained, nothing will be shown.

1. To register by specifying an IP address, select "Manual Network Camera Configuration," and then enter the "IP Address (Hostname)◆," "ID◆," and "Password◆" for the network camera.
2. To select from the Network Camera Search List, select "Select from Network Camera Search List." Select the network camera to register from the "Network Camera Search List" (multiple selections allowed), and then enter the "Hostname," "ID◆," and "Password◆." When entering the hostname, configure the "DNS" settings in Administrator mode. To search again, click **[Search]**. It is also possible change the search time.
3. Click **[Get Network Camera Information]**.
(Obtaining the video profile may take several minutes.)
When video profiles are successfully obtained, they will be shown in "Network Camera Information."
4. Choose the video profile to be registered from the list. (Multiple selections allowed.)
5. Click **[OK]** to register the network camera.

3.4 Group

Compatible type	<input type="checkbox"/> IXG-2C7(-*) <input type="checkbox"/> IXG-MK <input checked="" type="checkbox"/> IX-MV7-* <input type="checkbox"/> IXG-DM7(-*) <input type="checkbox"/> IX-DA <input type="checkbox"/> IX-BA <input type="checkbox"/> IX-DV, IX-DVF(-*) <input type="checkbox"/> IX-SSA(-*) <input type="checkbox"/> IX-EA, IX-EAU <input type="checkbox"/> IX-FA <input type="checkbox"/> IXGW-LC <input type="checkbox"/> IXGW-GW <input type="checkbox"/> Intercom App <input type="checkbox"/> IX-SS-2G <input type="checkbox"/> IX-RS-*
-----------------	--

Configure the group for groups calls, group pages, and contact input calls.

Up to 50 stations can be added per group (when registering a Mobile App, 49 stations per group and a single unit containing the Mobile App), and up to 99 groups can be configured.

Move row

Up to 50 station number rows can be displayed at a time. Switch the screen as follows.

[Previous]: Display the previous 50 rows.

[Next]: Display the next 50 rows.

[Apply]: Enter the station number and click

[Apply] to move the cursor to the row of the station number that was entered.

Move column

Up to 50 station number columns can be displayed at a time. Switch the screen as follows.

[Previous]: Display the previous 50 columns.

[Next]: Display the next 50 columns.

[Apply]: Enter the station number and click **[Apply]** to move

the cursor to the column of the station number that was entered.

Row

Enter Station Number

Column

Enter Station Number

[Display settings]

Group Number

01

U = Unicast, M = Multicast
If designating "M", multicast IP addresses must be configured for the station(s).

Building Number	Unit Number	Station Name	System Information				System Information Required settings.	
			Group				Group	
			01				01	
			Number	Name	Type	Total	Station Number / Station Name / Station Type	
01	002	Master Station1	01	Commercial106	Audio Protocol	2		
					Video Protocol	1		
01	106	Master Station1	01	Inside Area 002	Audio Protocol	1		U
					Video Protocol	0		

! Important

- Always set "[Language \(→page 75\)](#)" before setting "Group."
- Enter using the language set in "[Language \(→page 75\)](#)". However, if the language (configured on the station main unit) displayed on the screen for IXG-MK or IX-MV7-* is different from the language set with "[Language \(→page 75\)](#)", the characters displayed on the station screen may appear incorrectly. To avoid this, enter information using alphabetical characters only.
- A station cannot be registered to a group unless the "IP Address" settings have been configured in Administrator mode and the station has been registered in "[Station List \(→page 83\)](#)". In addition, units (Mobile App) which are not registered on "[Mobile App List \(→page 86\)](#)" cannot be registered to a group.
- Groups calls and contact input calls cannot be made to an Door Stations or Entrance Station.
- Results when searching by station will be listed in order of group number.

3.4.1 Configuring a Group

Configure the group to register in each station.

U = Unicast, M = Multicast
If designating "M", multicast IP addresses must be configured for the station(s).

Building Number	Unit Number	Station Name	Number	Name	Type	Total
01	002	Master Station	01	Inside Area 002	Audio Protocol	1
01	002	Master Station	01	Inside Area 002	Video Protocol	1
01	002	Master Station	01	Inside Area 002	Audio Protocol	1
01	002	Master Station	01	Inside Area 002	Video Protocol	1
01	106	Master Station	01	Inside Area 002	Audio Protocol	2
01	106	Master Station	01	Inside Area 002	Video Protocol	2

System Information: Group 01

Station Number / Station Name / Station Type: 0010 / Entrance Station1 / IX-G-DM7(-*) | 0020 / Master Station 1 / IX-MV7-* | 0021 / ...

Mobile App: Building Number, Unit Number, Unit Name

1. Select the group to configure from "Group Number."
The Settings screen for the selected group will be shown on the screen.
2. Enter the following information in "Group Information."
 - Number: 01-99
Group numbers must be unique.
 - Name: 1-24 alphanumeric characters
3. Search for the station to be configured from "list of IX-MV7-* in setting data."
4. Search for the station to be registered from the "list of stations that can be registered to group."

- 5.** Click the cells that correspond to Steps 3 and 4. Select an audio protocol and video protocol setting value for each, and register to a group.

The number of registered stations will be displayed in "Total."

Audio Protocol

- Blank: Select to not register to a group.
- U: Register to group. Audio will be transmitted in unicast during group paging.
- M: Register to group. Audio will be transmitted in multicast during group paging.

Video protocol (only when IX-MV7-*, IXG-MK, or IXG-2C7(-*) is the station to register)

- Blank: Video will be transmitted as multicast.
- U: Video will be transmitted in unicast during group calls. Unicast can reach up to 20 stations.
- M: Video will be transmitted in multicast during group calls.

The video protocol pull-down menu is shown when the audio protocol setting is selected.

- 6.** To register a Mobile App to a group, click "Mobile App" - **[Select]**.

- 7.** Select the unit containing the Mobile App to register to the group.

- 8.** Click **[OK]**.
- Click **[Cancel]** to quit without registering a Mobile App.

- 9.** After configuration is complete, click **[Update]**.

- 10.** Click **[OK]**.



Important

- If "M" is selected, or if "Blank" is selected for the video protocol setting, be sure to configure "Multicast Address" in Administrator mode.



Note

- When making a group call, the audio protocol will be set to "U" and cannot be changed.

4. Call Settings (Move-in Settings)

4.1 Called Stations (Door/Sub Stations)

Compatible type	<input type="checkbox"/> IXG-2C7(-*) <input type="checkbox"/> IXG-MK <input type="checkbox"/> IX-MV7-* <input type="checkbox"/> IXG-DM7(-*) <input checked="" type="checkbox"/> IX-DA <input checked="" type="checkbox"/> IX-BA <input checked="" type="checkbox"/> IX-DV, IX-DVF(-*) <input checked="" type="checkbox"/> IX-SSA(-*) <input checked="" type="checkbox"/> IX-EA, IX-EAU <input type="checkbox"/> IX-FA <input type="checkbox"/> IXGW-LC <input type="checkbox"/> IXGW-GW <input type="checkbox"/> Intercom App <input checked="" type="checkbox"/> IX-SS-2G <input checked="" type="checkbox"/> IX-RS-*
-----------------	--

Configure the group to call when a call is made using the call button or via contact input.

- Except for IX-DA, IX-BA: Up to 20 stations can be added per group (when registering a Mobile App, 19 stations per group and a single unit containing the Mobile App), and up to 10 groups can be configured.
- IX-DA and IX-BA: Up to 20 stations can be added per group (when registering a Mobile App, 19 stations per group and a single unit containing the Mobile App), and only a single group can be configured.
- IXG-2C7(-*), IXG-MK, IX-MV7-*, and IX-RS-* stations can be registered as destinations.

! Important

- To unlock the door release for IX-RS-* when in communication with Entrance Stations or Door Stations, register the Entrance Stations or Door Stations in the group. However, outgoing calls cannot be placed for Entrance Stations or Door Stations.

Move row

Up to 50 station number rows can be displayed at a time. Switch the screen as follows.
[Previous]: Display the previous 50 rows.
[Next]: Display the next 50 rows.
[Apply]: Enter the station number and click **[Apply]** to move the cursor to the row of the station number that was entered.

Move column

Up to 50 station number columns can be displayed at a time. Switch the screen as follows.
[Previous]: Display the previous 50 columns.
[Next]: Display the next 50 columns.
[Apply]: Enter the station number and click **[Apply]** to move the cursor to the column of the station number that was entered.

Move to Related Settings

Moves to the selected item within the same Settings screen.

1

2

3

4

5

List of Door Stations and Handset Sub Stations in setting data

List of stations that can be registered to group

 **Important**

- A station cannot be registered as a destination unless "IP Address" has been configured for the station in Administrator mode.

How to configure destinations (Door/Sub Stations)

1. Select the group to configure from "Display settings."
 - The Settings screen for the selected group will be displayed.
 - Use the following groups when configuring the IX-DA and IX-BA call destination.
 - Groups used to place a call by operating the call button: "Group number 10"
 - Groups used to place a call by Option Input: "Group number 01 - 09"
2. Search for the station to be configured from "list of Door Stations and Handset Sub Stations in setting data."
3. Search for the station to be registered from the "list of stations that can be registered to group."
4. Click the cells that correspond to Steps 2 and 3. Select the setting value and register to the group.
 - The number of registered stations will be displayed in "Total."
 - Blank: Select to not register to a group.
 - U: Register to group. Video and audio will be transmitted in unicast when making an outgoing call.
 - M: Register to group. Video transmitted in multicast and audio will be transmitted in unicast when making an outgoing call.
 - This can only be configured if the station to configure is IX-DV, IX-DVF(-*), IX-DA, IX-EA, or IX-EAU, and the destination is IX-MV7-*, IXG-MK, or IXG-2C7(-*).
5. To register a Mobile App to a group, click "Mobile App" - **[Select]**.
6. Select the unit containing the Mobile App to register to the group.

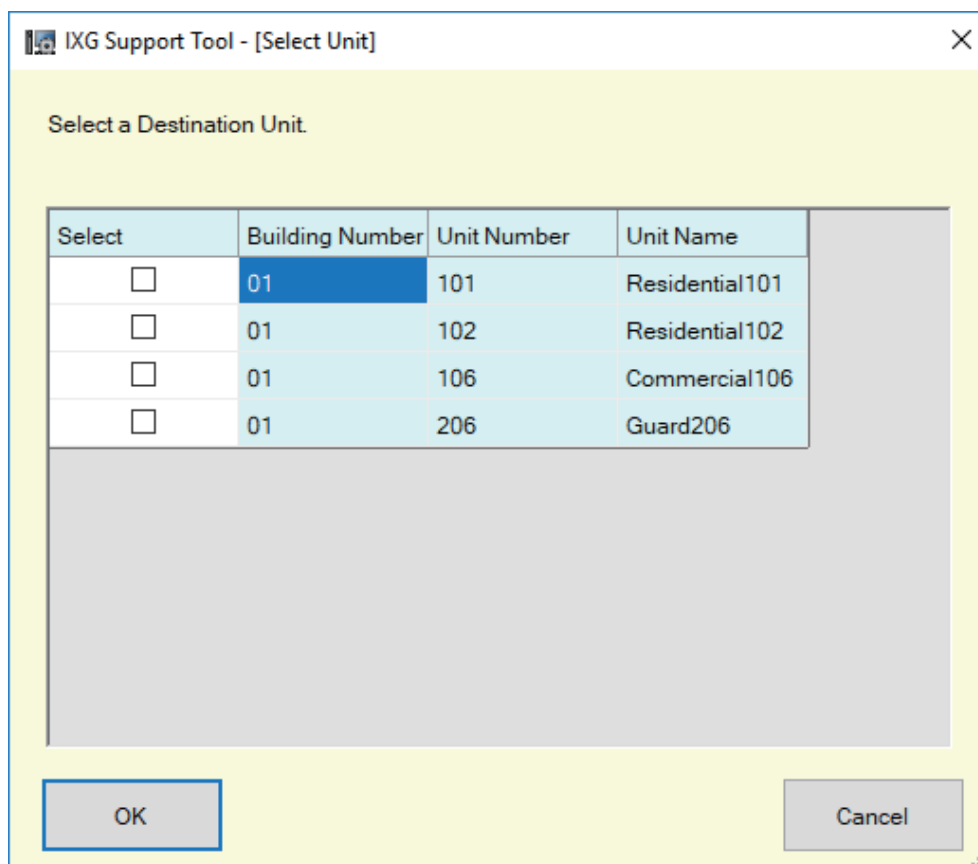

7. Click **[OK]**.
 - Click **[Cancel]** to quit without registering a Mobile App.

8. After configuration is complete, click **[Update]**.
9. Click **[OK]**.

 **Important**

- If "M" is selected, be sure to configure "Multicast Address" in Administrator mode.

4.2 Guard Button

Configure the station to be called when the "Guard Call Button" is pressed on the Entrance Station or Tenant Station. IXG-MK, IX-MV7-*, and IX-RS-* stations can be set as destinations.

Building Number	Unit Number	Unit Name	Call Settings Required settings.									
			Guard Button									
			Select Station	Button Number1			Button Number2					
Station Number	Building Number	Unit Number		Station Name	Station Number	Building Number	Unit Number	Station Name				
01	001	Entrance001	Select									
01	101	Residential101	Select									
01	102	Residential102	Select									
01	103	Residential103	Select									
01	104	Residential104	Select									

! Important

- A station cannot be set as a destination unless "IP Address" has been configured for the station in Administrator mode.

■ Select Station

Compatible type	<input checked="" type="checkbox"/> IXG-2C7(-*) <input type="checkbox"/> IXG-MK <input type="checkbox"/> IX-MV7-* <input checked="" type="checkbox"/> IXG-DM7(-*) <input type="checkbox"/> IX-DA <input type="checkbox"/> IX-BA <input type="checkbox"/> IX-DV, IX-DVF(-*) <input type="checkbox"/> IX-SSA(-*) <input type="checkbox"/> IX-EA, IX-EAU <input type="checkbox"/> IX-FA <input type="checkbox"/> IXGW-LC <input type="checkbox"/> IXGW-GW <input type="checkbox"/> Intercom App <input type="checkbox"/> IX-SS-2G <input type="checkbox"/> IX-RS-*
Description	Configure the call destination station (the station number). Up to 8 call destination stations can be configured. Enter the station number or click [Select] to select one. The information (building number, unit number, station name) for the configured station will be displayed.
Settings	Multiple Building System: 3-24 digits Single Building System: 3-5 digits

■ Mobile App

Compatible type	<input checked="" type="checkbox"/> IXG-2C7(-*) <input type="checkbox"/> IXG-MK <input type="checkbox"/> IX-MV7-* <input checked="" type="checkbox"/> IXG-DM7(-*) <input type="checkbox"/> IX-DA <input type="checkbox"/> IX-BA <input type="checkbox"/> IX-DV, IX-DVF(-*) <input type="checkbox"/> IX-SSA(-*) <input type="checkbox"/> IX-EA, IX-EAU <input type="checkbox"/> IX-FA <input type="checkbox"/> IXGW-LC <input type="checkbox"/> IXGW-GW <input type="checkbox"/> Intercom App <input type="checkbox"/> IX-SS-2G <input type="checkbox"/> IX-RS-*
Description	Select the unit containing the Mobile App to configure as a destination. Up to 1 destination unit can be configured. Enter the building number and unit number of the unit containing the Mobile App, or click [Select] to select it. The information (building number, unit number, unit name) for the configured Mobile App is displayed.
Settings	Building Number: 01-99 Unit Number: 3-4 digits (Single Building System), 3-10 digits (Multiple Building System)

5. Move-out Settings (Move-out Settings)

5.1 Resident Move-out

Prevent previous residents from using the Mobile App once they have moved out.

Send a QR code for new residents to the registered Tenant Station.

Resident Move-out										
Move-out Settings										
Resident Move-out										
Building Number	Unit Number	Unit Name	Select	Station Number	Station Name	First Name	Last Name	Initialize User Settings	Deactivate Apps	Upload QR Code
01	101	Residential101	<input type="checkbox"/>	1010	Tenant Station1	Derek	McNeill	-	-	-
01	101	Residential101	<input type="checkbox"/>	1012	Tenant Station2	Derek	McNeill	-	-	-
01	102	Residential102	<input type="checkbox"/>	1020	Tenant Station1	Sean	Peterson	-	-	-
01	103	Residential103	<input type="checkbox"/>	1030	Tenant Station1	John	Ford	-	-	-
01	104	Residential104	<input type="checkbox"/>	1040	Tenant Station1	Jordana	Kidd	-	-	-
01	105	Residential105	<input type="checkbox"/>	1050	Tenant Station1	Joy	Sweet	-	-	-
01	201	Residential201	<input type="checkbox"/>	2010	Tenant Station1			-	-	-
01	202	Residential202	<input type="checkbox"/>	2020	Tenant Station1			-	-	-
01	203	Residential203	<input type="checkbox"/>	2030	Tenant Station1			-	-	-
01	204	Residential204	<input type="checkbox"/>	2040	Tenant Station1			-	-	-
01	205	Residential205	<input type="checkbox"/>	2050	Tenant Station1			-	-	-

List of Residential Unit

How to perform Resident Move-out

1. In the "List of residences in the setting data," select the unit for which to perform the move-out process.
2. Click **[Resident Move-out]**.
3. Click **[OK]**.
 - Click **[Cancel]** to quit without performing the move-out process.
4. Enter the "IXG Cloud Server ID" and "Password."
5. Click "Login."
 - Login to IXG Cloud Server.
 - Click **[Cancel]** to quit without performing IXG Cloud Server Login.

The following processes will be performed.

- First Name / Last Name: "First Name," and "Last Name" will be returned to their default values.
- Initialize User Settings: The user settings of the Tenant Station will be initialized.
- Deactivate Apps: The previous residents will not be able to use the App.
- Upload QR Code: Upload a new QR code to the Tenant Station.

6. Click **[OK]**.
7. If there is no Tenant Station, generate a PDF of the QR Code for App Registration.

["Export QR Code for App Registration \(→page 68\)"](#)

5.2 Delete Unit Information

Delete the unit information if necessary, such as when a resident moves out.

Unit Information and registered App will be deleted.

Select	Building Number	Unit Number	Move-out Settings
			Delete Unit Information
			Unit Name
<input type="checkbox"/>	01	101	Residential101
<input type="checkbox"/>	01	102	Residential102
<input type="checkbox"/>	01	103	Residential103
<input type="checkbox"/>	01	104	Residential104
<input type="checkbox"/>	01	105	Residential105
<input type="checkbox"/>	01	201	Residential201
<input type="checkbox"/>	01	202	Residential202
<input type="checkbox"/>	01	203	Residential203
<input type="checkbox"/>	01	204	Residential204
<input type="checkbox"/>	01	205	Residential205
<input type="checkbox"/>	01	208	Residential208

List of Residential information in the setting data

How to delete unit information

1. In the "List of Residential information in the setting data," select the unit for which to delete the unit information.
2. Click **[Delete]**.
 - "Unit Name" will be blank.
3. Click **[Update]**.
4. Click **[OK]**.

6. Entrance Station Settings (Misc.)

6.1 Access Code

Set the access code for each unit used at the Entrance Station to open the door.

Filter
 Building Number / Building Name: Select the building to display.
 Station Number / Station Name: Select the station to display and then click **[Apply]**. The access codes for each unit will be displayed.

Length: length of access codes.

["Add Access Code \(→page 104\)"](#)

["Delete Access Code \(→page 105\)"](#)

Filter

Building Number / Building Name: 01/ 1 Apply

Station Number / Station Name: 0010/Entrance Station1

Length: 4

Add Access Code

Delete Access Code

Building Number	Unit Number	Unit Name	Entrance Station Settings			Required settings.
			Access Code	Access Code		
				Relay Output 1	Relay Output 2	
01	002	Inside Area 002				
01	003	Outside Area 003				
01	101	Residential101				
01	102	Residential102				
01	103	Residential103				
01	104	Residential104				
01	105	Residential105				
01	106	Commercial106				
01	201	Residential201				
01	202	Residential202				
01	203	Residential203				
01	204	Residential204				
01	205	Residential205				

How to configure access codes

1. Use "Filter" to select the Entrance Station for which to configure an access code, and then click **[Apply]**.
 - The Settings screen for the selected Entrance Station will be displayed.

2. Enter the access code for each unit.
 - Access Code: Configure using the number of digits displayed in "Length."
 - If "Door Release" was set for Relay Output 1 for Entrance Station in "Relay Output" - "Function" in Administrator mode, enter "A" + "Access Code" when performing a door release on the Entrance Station.
 - If "Door Release" was set for Relay Output 2 for Entrance Station in "Relay Output" - "Function" in Administrator mode, enter "B" + "Access Code" when performing a door release on the Entrance Station.

Filter

Building Number / Building Name: Apply

Station Number / Station Name:

Length

Add Access Code Delete Access Code

Building Number	Unit Number	Unit Name	Entrance Station Settings			Required settings.
			Access Code	Access Code		
				Relay Output 1	Relay Output 2	
01	002	Inside Area 002	1111	A1111		
01	003	Outside Area 003				
01	101	Residential101				
01	102	Residential102				
01	103	Residential103				
01	104	Residential104				
01	105	Residential105				
01	106	Commercial106				
01	201	Residential201				
01	202	Residential202				
01	203	Residential203				

3. Click **[Update]**.
4. Click **[OK]**.

6.1.1 Add Access Code

Configure the access code for each unit.

Click **[Add Access Code]**. The "Add Access Code" screen will be displayed.

IXC Support Tool - [Add Access Code]

Add Access Code

Access Code

Select a Unit to associate to this Access Code.

Building Number

Unit Number

Select Entrances to release the door by this Access Code.

Select	Building Number	Unit Number	Station Name	Length
<input type="checkbox"/>	01	001	Entrance Station1	4

Required settings.

Add Cancel

■ How to add Access Codes

1. Enter the "Access Code."
 - Access Code: Configures using the number of digits displayed under Length.
2. Select the "Building Number" of the unit to assign the access code, and then enter the "Unit Number."
3. Select the Entrance Station where to add the access code. (Multiple selections allowed.)
4. Click **[Add]**.
 - Click **[Cancel]** to exit.
5. Click **[Update]**.
6. Click **[OK]**.

 **Note**

- To confirm the configured access codes, use "Filter" to select the "Building Number / Building Name" and "Station Number / Station Name" for the Entrance Station, and then click **[Apply]**.

6.1.2 Delete Access Code

Delete registered access codes.

Click **[Delete Access Code]**. The "Delete Access Code" screen will be displayed.

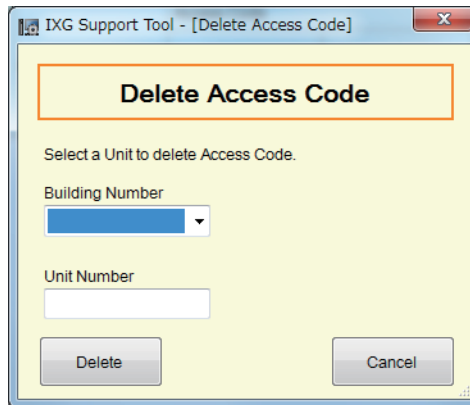

■ How to delete access codes

1. Select the "Building Number" of the unit to delete an access code, and then enter the "Unit Number."
2. Click **[Delete]**.
 - Click **[Cancel]** to exit.
3. Click **[Update]**.
4. Click **[OK]**.

 **Note**

- To confirm whether an access code was deleted, use "Filter" to select the "Building Number / Building Name" and "Station Number / Station Name" for the Entrance Station, and then click **[Apply]**.

6.2 Welcome Screen

An image may be set as a Welcome Screen to be displayed prior to seeing the operation screen.

Building Number	Unit Number	Station Name	Entrance Station Settings				
			Welcome Screen Settings				
			Welcome Screen Wallpaper	Image1			
Display	File name	...		Delete			
01	001	Entrance Station1	<input checked="" type="checkbox"/>	<input type="checkbox"/>		...	<input type="checkbox"/>

6.2.1 Welcome Screen Wallpaper

Compatible type	<input type="checkbox"/> IXG-2C7(-*) <input type="checkbox"/> IXG-MK <input type="checkbox"/> IX-MV7-* <input checked="" type="checkbox"/> IXG-DM7(-*) <input type="checkbox"/> IX-DA <input type="checkbox"/> IX-BA <input type="checkbox"/> IX-DV, IX-DVF(-*) <input type="checkbox"/> IX-SSA(-*) <input type="checkbox"/> IX-EA, IX-EAU <input type="checkbox"/> IX-FA <input type="checkbox"/> IXGW-LC <input type="checkbox"/> IXGW-GW <input type="checkbox"/> Intercom App <input type="checkbox"/> IX-SS-2G <input type="checkbox"/> IX-RS-*
Description	Configure whether to display the Welcome Screen.
Settings	<ul style="list-style-type: none"> • Checked: Enable • Unchecked: Disable

6.2.2 Image 1

Register the image to display if "Checked: Enable" was set in "Welcome Screen Wallpaper."
If no image is registered, the default Welcome Screen will be displayed.

■ Display

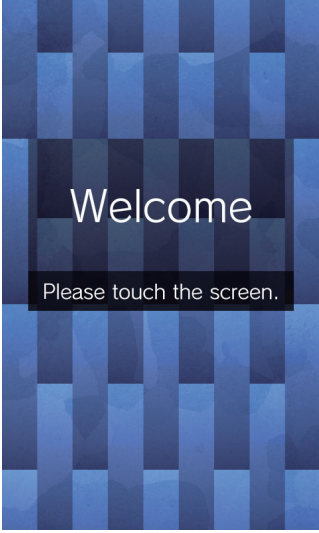
Compatible type	<input type="checkbox"/> IXG-2C7(-*) <input type="checkbox"/> IXG-MK <input type="checkbox"/> IX-MV7-* <input checked="" type="checkbox"/> IXG-DM7(-*) <input type="checkbox"/> IX-DA <input type="checkbox"/> IX-BA <input type="checkbox"/> IX-DV, IX-DVF(-*) <input type="checkbox"/> IX-SSA(-*) <input type="checkbox"/> IX-EA, IX-EAU <input type="checkbox"/> IX-FA <input type="checkbox"/> IXGW-LC <input type="checkbox"/> IXGW-GW <input type="checkbox"/> Intercom App <input type="checkbox"/> IX-SS-2G <input type="checkbox"/> IX-RS-*
Description	<p>Configure whether to display the registered image on the Welcome Screen. Only a single image file can be displayed.</p> 
Settings	<ul style="list-style-type: none"> • Checked: Enable • Unchecked: Disable

■ File name

Compatible type	<input type="checkbox"/> IXG-2C7(-*) <input type="checkbox"/> IXG-MK <input type="checkbox"/> IX-MV7-* <input checked="" type="checkbox"/> IXG-DM7(-*) <input type="checkbox"/> IX-DA <input type="checkbox"/> IX-BA <input type="checkbox"/> IX-DV, IX-DVF(-*) <input type="checkbox"/> IX-SSA(-*) <input type="checkbox"/> IX-EA, IX-EAU <input type="checkbox"/> IX-FA <input type="checkbox"/> IXGW-LC <input type="checkbox"/> IXGW-GW <input type="checkbox"/> Intercom App <input type="checkbox"/> IX-SS-2G <input type="checkbox"/> IX-RS-*
Description	<p>Register an image to display on the Welcome Screen.</p> <ul style="list-style-type: none"> • Message File Name: Up to 64 bytes of alphanumeric characters (including extension) • File format: PNG • Resolution: <ul style="list-style-type: none"> Width: 480 pixels Height: 800 pixels
Settings	<p>OK: Click [Browse] to select a file. To delete, place a check next to the [Delete] box.</p>

7. Transfer Settings (Misc.)

7.1 Absent Transfer

Configure the settings for absent transfer.

Absent Transfer: If an incoming call is received during absent transfer, the incoming call can be automatically transferred to a transfer destination.

Move row

Up to 50 station number rows can be displayed at a time. Switch the screen as follows.

[Previous]: Display the previous 50 rows.

[Next]: Display the next 50 rows.

[Apply]: Enter the station number and click **[Apply]** to move the cursor to the row of the station number that was entered.

Building Number	Unit Number	Station Name	Transfer Settings												
			Absent Transfer	Absent Transfer											
				Transfer Destination List											
		Select Unit	Select Station	Station Number										Mobile App	
				No.01	No.02	No.03	No.04	No.05	No.06	No.07	No.08	No.09	No.10	Building Number	
01	002	Master Station1	Disable	Select	Select Station										
01	106	Master Station1	Disable	Select	Select Station										

! Important

- A station cannot be set as a transfer destination unless "IP Address" has been configured for the station in Administrator mode.
- For IXG-MK, a Entrance Station or Door Station cannot be set as the transfer destination.
For IX-MV7-*, Door Stations other than Door Stations in your room cannot be set as the transfer destination. However, Outside Area Door Stations can be set as the transfer destination.

■ Absent Transfer

Compatible type	<input type="checkbox"/> IXG-2C7(-*) <input checked="" type="checkbox"/> IXG-MK <input checked="" type="checkbox"/> IX-MV7-* <input type="checkbox"/> IXG-DM7(-*) <input type="checkbox"/> IX-DA <input type="checkbox"/> IX-BA <input type="checkbox"/> IX-DV, IX-DVF(-*) <input type="checkbox"/> IX-SSA(-*) <input type="checkbox"/> IX-EA, IX-EAU <input type="checkbox"/> IX-FA <input type="checkbox"/> IXGW-LC <input type="checkbox"/> IXGW-GW <input type="checkbox"/> Intercom App <input type="checkbox"/> IX-SS-2G <input type="checkbox"/> IX-RS-*
Description	Configure whether to set absent transfer. The setting can also be changed using the button on the station main unit. If "Transfer Destination List" is not configured, this cannot be set to "Enable."
Settings	<ul style="list-style-type: none"> • Enable: Set absent transfer. • Disable: Do not set absent transfer.

Transfer Destination List

Compatible type	<input type="checkbox"/> IXG-2C7(-*) <input checked="" type="checkbox"/> IXG-MK <input checked="" type="checkbox"/> IX-MV7-* <input type="checkbox"/> IXG-DM7(-*) <input type="checkbox"/> IX-DA <input type="checkbox"/> IX-BA <input type="checkbox"/> IX-DV, IX-DVF(-*) <input type="checkbox"/> IX-SSA(-*) <input type="checkbox"/> IX-EA, IX-EAU <input type="checkbox"/> IX-FA <input type="checkbox"/> IXGW-LC <input type="checkbox"/> IXGW-GW <input type="checkbox"/> Intercom App <input type="checkbox"/> IX-SS-2G <input type="checkbox"/> IX-RS-*
Description	<p>To configure IX-MV7-*:</p> <p>Configure the transfer destination station (station number) and Mobile App when performing absent transfer. Up to 10 stations can be configured as transfer destinations (when registering a Mobile App, 9 stations and a single unit containing the Mobile App). However, if the call originating station is IX-DA or IX-BA, calls will only be transferred to the station entered for "No.01."</p> <p>To configure a station, enter the station number or click [Select Station] to select one.</p> <p>To configure a Mobile App, click "Mobile App" - [Select]. Select the unit containing the Mobile App to register as a transfer destination, and then click [OK].</p> <p>To configure IXG-MK:</p> <p>Configure the transfer destination unit for absent transfer. A single unit can be configured as a transfer destination. However, if the call originating station is IX-DA or IX-BA, calls will be transferred only to the master station with the lowest station number among the stations belonging to the selected unit.</p> <p>To configure a unit, click [Select].</p> <p>Up to 10 stations can be configured as transfer destinations if configuring by directly entering station numbers (when registering a Mobile App, 9 stations and a single unit containing the Mobile App). However, if the call originating station is IX-DA or IX-BA, calls will be transferred only to the station entered for "No.01."</p> <p>To configure a Mobile App, click [Select] of "Mobile App." Select the unit containing the Mobile App to register as a transfer destination and click [OK].</p>
Settings	<p>Multiple building system: 3-24 digits</p> <p>Single building system: 3-5 digits</p>

Note

- To register a "Mobile App," first register the "Mobile App" in "[Mobile App List \(→page 86\)](#)". A "Mobile App" registered in a "Mobile App List" can be registered as a transfer destination "Mobile App."

Re-Transfer Destination

Compatible type	<input type="checkbox"/> IXG-2C7(-*) <input checked="" type="checkbox"/> IXG-MK <input checked="" type="checkbox"/> IX-MV7-* <input type="checkbox"/> IXG-DM7(-*) <input type="checkbox"/> IX-DA <input type="checkbox"/> IX-BA <input type="checkbox"/> IX-DV, IX-DVF(-*) <input type="checkbox"/> IX-SSA(-*) <input type="checkbox"/> IX-EA, IX-EAU <input type="checkbox"/> IX-FA <input type="checkbox"/> IXGW-LC <input type="checkbox"/> IXGW-GW <input type="checkbox"/> Intercom App <input type="checkbox"/> IX-SS-2G <input type="checkbox"/> IX-RS-*
Description	<p>Configure the transfer destination station (station number) and Mobile App when performing absent transfer again for a transferred call. Only a single station can be configured as a transfer destination. However, if the call originating station is IX-DA or IX-BA, the call will arrive without being retransferred.</p> <p>To configure a station, enter the station number or click [Select Station] to select one.</p> <p>To configure a Mobile App, click "Mobile App" - [Select]. Select the unit containing the Mobile App to register as a transfer destination, and then click [OK].</p>
Settings	<p>Multiple building system: 3-24 digits</p> <p>Single building system: 3-5 digits</p>

Note

- To register a "Mobile App," first register the "Mobile App" in "[Mobile App List \(→page 86\)](#)". A "Mobile App" registered in a "Mobile App List" can be registered as a transfer destination "Mobile App."

7.2 Delay Transfer

Configure the settings for delay transfer.

Delay Transfer: If an incoming call is received during delay transfer, the call can be automatically transferred to the transfer destination after a certain period of time (the set delay time) elapses with no response.

Move row

Up to 50 station number rows can be displayed at a time. Switch the screen as follows.

[Previous]: Display the previous 50 rows.

[Next]: Display the next 50 rows.

[Apply]: Enter the station number and click **[Apply]** to move the cursor to the row of the station number that was entered.

Building Number	Unit Number	Station Name	Transfer Settings		Transfer Destination List												
			Delay Transfer	Delay Time [sec]	Select Unit	Select Station	No. 01	No. 02	No. 03	No. 04	No. 05	No. 06	No. 07	No. 08	No. 09	No. 10	Mobile App Building Number
01	002	Master Station 1	Disable	30	Select	Select Station											
01	106	Master Station 1	Disable	30	Select	Select Station											

! Important

- A station cannot be set as a transfer destination unless "IP Address" has been configured for the station in Administrator mode.
- For IXG-MK, a Entrance Station or Door Station cannot be set as the transfer destination.
For IX-MV7-*, Door Stations other than Door Stations in your room cannot be set as the transfer destination. However, Outside Area Door Stations can be set as the transfer destination.

■ Delay Transfer

Compatible type	<input type="checkbox"/> IXG-2C7(-*) <input checked="" type="checkbox"/> IXG-MK <input checked="" type="checkbox"/> IX-MV7-* <input type="checkbox"/> IXG-DM7(-*) <input type="checkbox"/> IX-DA <input type="checkbox"/> IX-BA <input type="checkbox"/> IX-DV, IX-DVF(-*) <input type="checkbox"/> IX-SSA(-*) <input type="checkbox"/> IX-EA, IX-EAU <input type="checkbox"/> IX-FA <input type="checkbox"/> IXGW-LC <input type="checkbox"/> IXGW-GW <input type="checkbox"/> Intercom App <input type="checkbox"/> IX-SS-2G <input type="checkbox"/> IX-RS-*
Description	Select Enable / Disable for Delay Transfer. If "Transfer Destination List" is not configured, this cannot be set to "Enable."
Settings	<ul style="list-style-type: none"> • Enable: Delay transfer enabled. • Disable: Delay transfer disabled.

■ Delay Time [sec]◆

Compatible type	<input type="checkbox"/> IXG-2C7(-*) <input checked="" type="checkbox"/> IXG-MK <input checked="" type="checkbox"/> IX-MV7-* <input type="checkbox"/> IXG-DM7(-*) <input type="checkbox"/> IX-DA <input type="checkbox"/> IX-BA <input type="checkbox"/> IX-DV, IX-DVF(-*) <input type="checkbox"/> IX-SSA(-*) <input type="checkbox"/> IX-EA, IX-EAU <input type="checkbox"/> IX-FA <input type="checkbox"/> IXGW-LC <input type="checkbox"/> IXGW-GW <input type="checkbox"/> Intercom App <input type="checkbox"/> IX-SS-2G <input type="checkbox"/> IX-RS-*
Description	Set the delay time between receiving and transferring a call.
Settings	1-300 seconds (by 1 sec.)

Transfer Destination List

Compatible type	<input type="checkbox"/> IXG-2C7(-*) <input checked="" type="checkbox"/> IXG-MK <input checked="" type="checkbox"/> IX-MV7-* <input type="checkbox"/> IXG-DM7(-*) <input type="checkbox"/> IX-DA <input type="checkbox"/> IX-BA <input type="checkbox"/> IX-DV, IX-DVF(-*) <input type="checkbox"/> IX-SSA(-*) <input type="checkbox"/> IX-EA, IX-EAU <input type="checkbox"/> IX-FA <input type="checkbox"/> IXGW-LC <input type="checkbox"/> IXGW-GW <input type="checkbox"/> Intercom App <input type="checkbox"/> IX-SS-2G <input type="checkbox"/> IX-RS-*
Description	<p>To configure IX-MV7-*:</p> <p>Configure the transfer destination station (station number) and Mobile App when performing delay transfer. Up to 10 stations can be configured as transfer destinations (when registering a Mobile App, 9 stations and a single unit containing the Mobile App). However, if the call originating station is IX-DA or IX-BA, calls will only be transferred to the station entered for "No.01."</p> <p>To configure a station, enter the station number or click [Select Station] to select one.</p> <p>To configure a Mobile App, click "Mobile App" - [Select]. Select the unit containing the Mobile App to register as a transfer destination, and then click [OK].</p> <p>To configure IXG-MK:</p> <p>Configure the transfer destination unit for delay transfer. A single unit can be configured as a transfer destination. However, if the call originating station is IX-DA or IX-BA, calls will be transferred only to the master station with the lowest station number among the stations belonging to the selected unit.</p> <p>To configure a unit, click [Select].</p> <p>Up to 10 stations can be configured as transfer destinations if configuring by directly entering station numbers (when registering a Mobile App, 9 stations and a single unit containing the Mobile App). However, if the call originating station is IX-DA or IX-BA, calls will be transferred only to the station entered for "No.01."</p> <p>To configure a Mobile App, click [Select] of "Mobile App." Select the unit containing the Mobile App to register as a transfer destination and click [OK].</p>
Settings	Multiple building system: 3-24 digits Single building system: 3-5 digits

Note

- To register a "Mobile App," first register the "Mobile App" in "[Mobile App List \(→page 86\)](#)". A "Mobile App" registered in a "Mobile App List" can be registered as a transfer destination "Mobile App."

Re-Transfer Destination

Compatible type	<input type="checkbox"/> IXG-2C7(-*) <input checked="" type="checkbox"/> IXG-MK <input checked="" type="checkbox"/> IX-MV7-* <input type="checkbox"/> IXG-DM7(-*) <input type="checkbox"/> IX-DA <input type="checkbox"/> IX-BA <input type="checkbox"/> IX-DV, IX-DVF(-*) <input type="checkbox"/> IX-SSA(-*) <input type="checkbox"/> IX-EA, IX-EAU <input type="checkbox"/> IX-FA <input type="checkbox"/> IXGW-LC <input type="checkbox"/> IXGW-GW <input type="checkbox"/> Intercom App <input type="checkbox"/> IX-SS-2G <input type="checkbox"/> IX-RS-*
Description	<p>Configure the transfer destination station (station number) and Mobile App when performing delay transfer again for a transferred call. Only a single station can be configured as a transfer destination. However, if the call originating station is IX-DA or IX-BA, the call will arrive without being retransferred.</p> <p>To configure a station, enter the station number or click [Select Station] to select one.</p> <p>To configure a Mobile App, click "Mobile App" - [Select]. Select the unit containing the Mobile App to register as a transfer destination, and then click [OK].</p>
Settings	Multiple building system: 3-24 digits Single building system: 3-5 digits

Note

- To register a "Mobile App," first register the "Mobile App" in "[Mobile App List \(→page 86\)](#)". A "Mobile App" registered in a "Mobile App List" can be registered as a transfer destination "Mobile App."

7.3 Schedule Transfer

Configure the settings for Schedule Transfer.

Schedule Transfer: A call can be automatically transferred to a transfer destination when an incoming call is received during the time period set in [“Weekly Schedule \(→page 113\)”](#) and [“Daily Schedule \(→page 116\)”](#).

Move row

Up to 50 station number rows can be displayed at a time. Switch the screen as follows.

[Previous]: Display the previous 50 rows.

[Next]: Display the next 50 rows.

[Apply]: Enter the station number and click **[Apply]** to move the cursor to the row of the station number that was entered.

Weekly schedule

Select the day and schedule range to configure. The Settings screen will be shown. [“Weekly Schedule \(→page 113\)”](#)

[“Daily Schedule \(→page 116\)”](#)

Move to Related Settings

Moves to the selected item within the same Settings screen.

! Important

- A station cannot be set as a transfer destination unless "IP Address" has been configured for the station in Administrator mode.
- Incoming calls will be transferred during the time period set in "Schedule Transfer," regardless of the settings in [“Absent Transfer \(→page 108\)”](#) and [“Delay Transfer \(→page 110\)”](#).
- For IXG-MK, a Entrance Station or Door Station cannot be set as the transfer destination. For IX-MV7-*, Door Stations other than Door Stations in your room cannot be set as the transfer destination. However, Outside Area Door Stations can be set as the transfer destination.

■ Schedule Transfer

Compatible type	<input type="checkbox"/> IXG-2C7(-*) <input checked="" type="checkbox"/> IXG-MK <input checked="" type="checkbox"/> IX-MV7-* <input type="checkbox"/> IXG-DM7(-*) <input type="checkbox"/> IX-DA <input type="checkbox"/> IX-BA <input type="checkbox"/> IX-DV, IX-DVF(-*) <input type="checkbox"/> IX-SSA(-*) <input type="checkbox"/> IX-EA, IX-EAU <input type="checkbox"/> IX-FA <input type="checkbox"/> IXGW-LC <input type="checkbox"/> IXGW-GW <input type="checkbox"/> Intercom App <input type="checkbox"/> IX-SS-2G <input type="checkbox"/> IX-RS-*
Description	Select Enable / Disable for Schedule Transfer. If “Weekly Schedule (→page 113)” or “Daily Schedule (→page 116)” is not configured, this cannot be set to "Enable."
Settings	Enable: Schedule transfer enabled. Disable: Schedule transfer disabled.

7.3.1 Weekly Schedule

Configure the transfer destination and transfer time for every day from Sunday through Saturday. 12 schedules can be set for each day.

Transfer Destination List

Compatible type	<input type="checkbox"/> IXG-2C7(-*) <input checked="" type="checkbox"/> IXG-MK <input checked="" type="checkbox"/> IX-MV7-* <input type="checkbox"/> IXG-DM7(-*) <input type="checkbox"/> IX-DA <input type="checkbox"/> IX-BA <input type="checkbox"/> IX-DV, IX-DVF(-*) <input type="checkbox"/> IX-SSA(-*) <input type="checkbox"/> IX-EA, IX-EAU <input type="checkbox"/> IX-FA <input type="checkbox"/> IXGW-LC <input type="checkbox"/> IXGW-GW <input type="checkbox"/> Intercom App <input type="checkbox"/> IX-SS-2G <input type="checkbox"/> IX-RS-*
Description	<p>To configure IX-MV7-*: Configure the transfer destination station (station number) and Mobile App when performing schedule transfer. Up to 10 stations can be configured as transfer destinations for each of the 12 day schedules (when registering a Mobile App, 9 stations and a single unit containing the Mobile App). However, if the call originating station is IX-DA or IX-BA, calls will only be transferred to the station entered for "No.01." To configure a station, enter the station number or click [Select Station] to select one. To configure a Mobile App, click "Mobile App" - [Select]. Select the unit containing the Mobile App to register as a transfer destination, and then click [OK].</p> <p>To configure IXG-MK: Configure the transfer destination unit for schedule transfer. Only a single unit can be configured as a transfer destination for each of the 12 day schedules. However, if the call originating station is IX-DA or IX-BA, calls will be transferred only to the master station with the lowest station number among the stations belonging to the selected unit. To configure a unit, click [Select]. Up to 10 stations can be configured as transfer destinations if configuring by directly entering station numbers (when registering a Mobile App, 9 stations and a single unit containing the Mobile App). However, if the call originating station is IX-DA or IX-BA, calls will be transferred only to the station entered for "No.01." To configure a Mobile App, click [Select] of "Mobile App." Select the unit containing the Mobile App to register as a transfer destination and click [OK].</p>
Settings	Multiple building system: 3-24 digits Single building system: 3-5 digits

Note

- To register a "Mobile App," first register the "Mobile App" in "[Mobile App List \(→page 86\)](#)". A "Mobile App" registered in a "Mobile App List" can be registered as a transfer destination "Mobile App."

Re-Transfer Destination

Compatible type	<input type="checkbox"/> IXG-2C7(-*) <input checked="" type="checkbox"/> IXG-MK <input checked="" type="checkbox"/> IX-MV7-* <input type="checkbox"/> IXG-DM7(-*) <input type="checkbox"/> IX-DA <input type="checkbox"/> IX-BA <input type="checkbox"/> IX-DV, IX-DVF(-*) <input type="checkbox"/> IX-SSA(-*) <input type="checkbox"/> IX-EA, IX-EAU <input type="checkbox"/> IX-FA <input type="checkbox"/> IXGW-LC <input type="checkbox"/> IXGW-GW <input type="checkbox"/> Intercom App <input type="checkbox"/> IX-SS-2G <input type="checkbox"/> IX-RS-*
Description	<p>Configure the transfer destination station (station number) and Mobile App when performing schedule transfer again for a transferred call. Only a single station can be configured as a transfer destination for each of the 12 day schedules. However, if the call originating station is IX-DA or IX-BA, the call will arrive without being retransferred. To configure a station, enter the station number or click [Select Station] to select one. To configure a Mobile App, click "Mobile App" - [Select]. Select the unit containing the Mobile App to register as a transfer destination, and then click [OK].</p>
Settings	Multiple building system: 3-24 digits Single building system: 3-5 digits

Note

- To register a "Mobile App," first register the "Mobile App" in "[Mobile App List \(→page 86\)](#)".
A "Mobile App" registered in a "Mobile App List" can be registered as a transfer destination "Mobile App."

Start Time

Compatible type	<input type="checkbox"/> IXG-2C7(-*) <input checked="" type="checkbox"/> IXG-MK <input checked="" type="checkbox"/> IX-MV7-* <input type="checkbox"/> IXG-DM7(-*) <input type="checkbox"/> IX-DA <input type="checkbox"/> IX-BA <input type="checkbox"/> IX-DV, IX-DVF(-*) <input type="checkbox"/> IX-SSA(-*) <input type="checkbox"/> IX-EA, IX-EAU <input type="checkbox"/> IX-FA <input type="checkbox"/> IXGW-LC <input type="checkbox"/> IXGW-GW <input type="checkbox"/> Intercom App <input type="checkbox"/> IX-SS-2G <input type="checkbox"/> IX-RS-*
Description	Set the Start Time to enable schedule transfer.
Settings	00:00 - 23:59

End Time

Compatible type	<input type="checkbox"/> IXG-2C7(-*) <input checked="" type="checkbox"/> IXG-MK <input checked="" type="checkbox"/> IX-MV7-* <input type="checkbox"/> IXG-DM7(-*) <input type="checkbox"/> IX-DA <input type="checkbox"/> IX-BA <input type="checkbox"/> IX-DV, IX-DVF(-*) <input type="checkbox"/> IX-SSA(-*) <input type="checkbox"/> IX-EA, IX-EAU <input type="checkbox"/> IX-FA <input type="checkbox"/> IXGW-LC <input type="checkbox"/> IXGW-GW <input type="checkbox"/> Intercom App <input type="checkbox"/> IX-SS-2G <input type="checkbox"/> IX-RS-*
Description	Configure the time at which to end schedule transfer. If set earlier than "Start Time," the end time will be the time the following day.
Settings	00:00 - 23:59

How to configure schedule display

Configure the day and schedule range shown on the Settings screen for the weekly schedule. The display can be filtered to show only the day and schedule to configure. Click **[Schedule View Adjustment]**. The following screen will be shown.

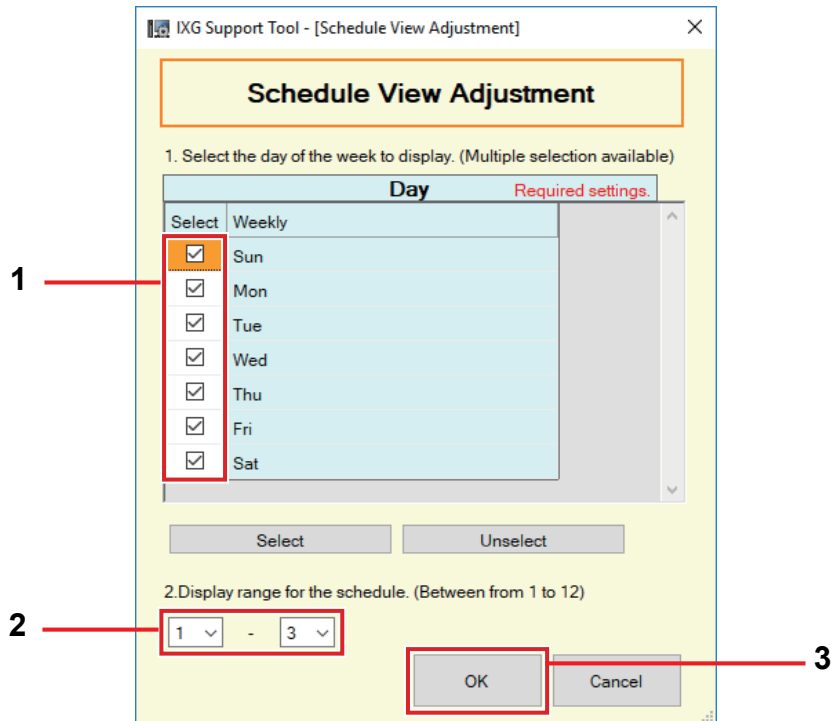

1. Select the day to display from "Day." (Multiple selections allowed.)
 - To select or unselect all days at once, click **[Select]** or **[Unselect]**.
 - By default, all days are shown.
2. Select the range of schedules to display (1 - 12) that can be configured for each day.
 - By default, the range of 1 - 3 is displayed.

3. Click **[OK]**.
 - Click **[Cancel]** to finish configuring the schedule display.

7.3.2 Daily Schedule

Configure the transfer destination and time for each individual day.
 A schedule one year from the set day can be configured. 12 schedules can be set for each day.

Move row

Up to 50 station number rows can be displayed at a time.
 Switch the screen as follows.
[Previous]: Display the previous 50 rows.
[Next]: Display the next 50 rows.
[Apply]: Enter the station number and click **[Apply]** to move the cursor to the row of the station number that was entered.

Daily schedule

Select the date and schedule range to configure. The Settings screen is displayed.

1. Select the date from the drop down menu.
2. Select the range of schedules to display (1 - 12) that can be configured for each day.
 - By default, the range of 1 - 3 is displayed.
3. Click **[Change to Daily Schedule Display]**.

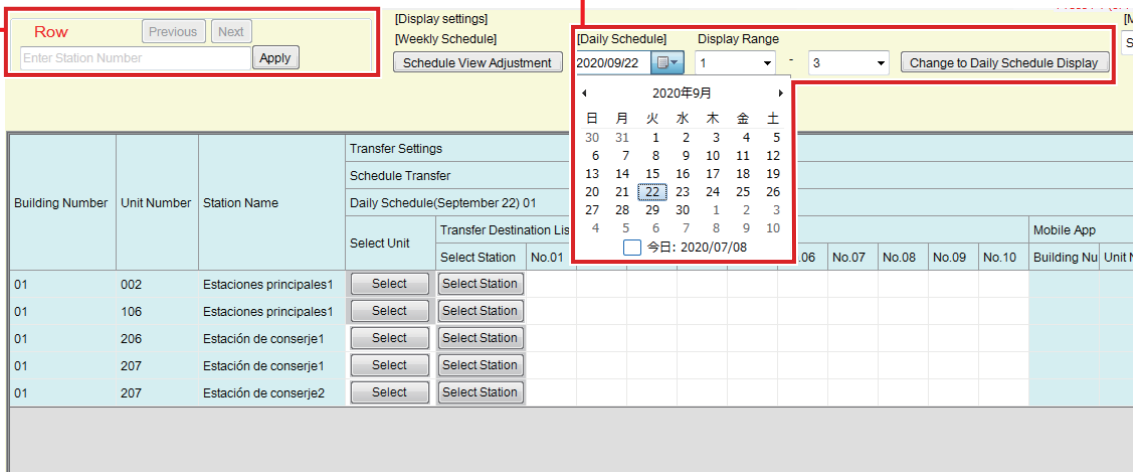

Transfer Destination List

Compatible type	<input type="checkbox"/> IXG-2C7(-*) <input checked="" type="checkbox"/> IXG-MK <input checked="" type="checkbox"/> IX-MV7-* <input type="checkbox"/> IXG-DM7(-*) <input type="checkbox"/> IX-DA <input type="checkbox"/> IX-BA <input type="checkbox"/> IX-DV, IX-DVF(-*) <input type="checkbox"/> IX-SSA(-*) <input type="checkbox"/> IX-EA, IX-EAU <input type="checkbox"/> IX-FA <input type="checkbox"/> IXGW-LC <input type="checkbox"/> IXGW-GW <input type="checkbox"/> Intercom App <input type="checkbox"/> IX-SS-2G <input type="checkbox"/> IX-RS-*
Description	<p>To configure IX-MV7-*: Configure the transfer destination station (station number) and Mobile App when performing schedule transfer. Up to 10 stations can be configured as transfer destinations for each of 12 day schedules (when registering a Mobile App, 9 stations and a single unit containing the Mobile App). However, if the call originating station is IX-DA or IX-BA, calls will only be transferred to the station entered for "No.01." To configure a station, enter the station number or click [Select Station] to select one. To configure a Mobile App, click "Mobile App" - [Select]. Select the unit containing the Mobile App to register as a transfer destination, and then click [OK].</p> <p>To configure IXG-MK: Configure the transfer destination unit for schedule transfer. Only a single unit can be configured as a transfer destination for each of the 12 day schedules. However, if the call originating station is IX-DA or IX-BA, calls will be transferred only to the master station with the lowest station number among the stations belonging to the selected unit. To configure a unit, click [Select]. Up to 10 stations can be configured as transfer destinations if configuring by directly entering station numbers (when registering a Mobile App, 9 stations and a single unit containing the Mobile App). However, if the call originating station is IX-DA or IX-BA, calls will be transferred only to the station entered for "No.01." To configure a Mobile App, click [Select] of "Mobile App." Select the unit containing the Mobile App to register as a transfer destination and click [OK].</p>
Settings	Multiple building system: 3-24 digits Single building system: 3-5 digits

Note

- To register a "Mobile App," first register the "Mobile App" in "[Mobile App List \(→page 86\)](#)". A "Mobile App" registered in a "Mobile App List" can be registered as a transfer destination "Mobile App."

Re-Transfer Destination

Compatible type	<input type="checkbox"/> IXG-2C7(-*) <input checked="" type="checkbox"/> IXG-MK <input checked="" type="checkbox"/> IX-MV7-* <input type="checkbox"/> IXG-DM7(-*) <input type="checkbox"/> IX-DA <input type="checkbox"/> IX-BA <input type="checkbox"/> IX-DV, IX-DVF(-*) <input type="checkbox"/> IX-SSA(-*) <input type="checkbox"/> IX-EA, IX-EAU <input type="checkbox"/> IX-FA <input type="checkbox"/> IXGW-LC <input type="checkbox"/> IXGW-GW <input type="checkbox"/> Intercom App <input type="checkbox"/> IX-SS-2G <input type="checkbox"/> IX-RS-*
Description	<p>Configure the transfer destination station (station number) when performing schedule transfer again for a transferred call. Only a single station can be configured as a transfer destination for each of the 12 day schedules. However, if the call originating station is IX-DA or IX-BA, the call will arrive without being retransferred. Enter the station number or click [Select Station] to select one. To configure a Mobile App, click "Mobile App" - [Select]. Select the unit containing the Mobile App to register as a transfer destination, and then click [OK].</p>
Settings	Multiple building system: 3-24 digits Single building system: 3-5 digits

Start Time

Compatible type	<input type="checkbox"/> IXG-2C7(-*) <input checked="" type="checkbox"/> IXG-MK <input checked="" type="checkbox"/> IX-MV7-* <input type="checkbox"/> IXG-DM7(-*) <input type="checkbox"/> IX-DA <input type="checkbox"/> IX-BA <input type="checkbox"/> IX-DV, IX-DVF(-*) <input type="checkbox"/> IX-SSA(-*) <input type="checkbox"/> IX-EA, IX-EAU <input type="checkbox"/> IX-FA <input type="checkbox"/> IXGW-LC <input type="checkbox"/> IXGW-GW <input type="checkbox"/> Intercom App <input type="checkbox"/> IX-SS-2G <input type="checkbox"/> IX-RS-*
Description	Set the Start Time to enable schedule transfer.
Settings	00:00 - 23:59

■ End Time

Compatible type	<input type="checkbox"/> IXG-2C7(-*) <input checked="" type="checkbox"/> IXG-MK <input checked="" type="checkbox"/> IX-MV7-* <input type="checkbox"/> IXG-DM7(-*) <input type="checkbox"/> IX-DA <input type="checkbox"/> IX-BA <input type="checkbox"/> IX-DV, IX-DVF(-*) <input type="checkbox"/> IX-SSA(-*) <input type="checkbox"/> IX-EA, IX-EAU <input type="checkbox"/> IX-FA <input type="checkbox"/> IXGW-LC <input type="checkbox"/> IXGW-GW <input type="checkbox"/> Intercom App <input type="checkbox"/> IX-SS-2G <input type="checkbox"/> IX-RS-*
Description	Configure the time at which to end schedule transfer. If set earlier than "Start Time," the end time will be the time the following day.
Settings	00:00 - 23:59



Additional Settings



1. Confirming Station Information

1.1 Confirming Station Information on the Entrance Station

Confirm the following information on the Entrance Station.

- Main: The firmware version for the main CPU
- Sub: The firmware version for the sub CPU (IXG-DM7-HID only)
- Station Number
- IP Address
- Subnet Mask
- Default Gateway
- Mac Address

1. Enter "ABAB1234" using the keypad.

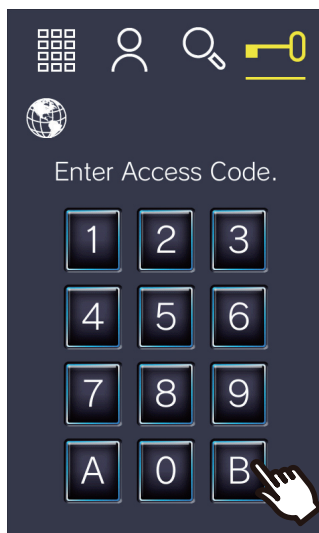

2. Confirm station information.

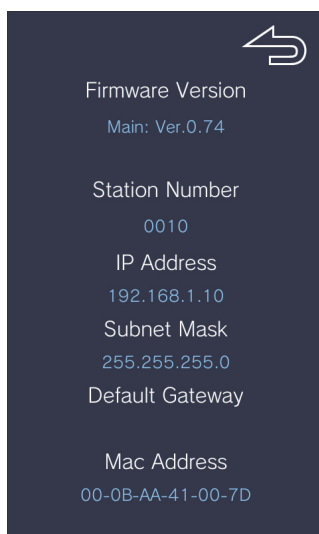

- Tap  to return to the previous screen.



Note

- If "Error" is displayed.
 - The access controller is turned off
 - The sub CPU is disconnected

1.2 Confirming property manager ID and password on the Tenant Station

Confirm the following information on the Tenant Station (firmware version: 2.00 or later).

- Administrator ID
- Administrator Password

1. Tap [SETTINGS] on the Home Screen



2. Tap

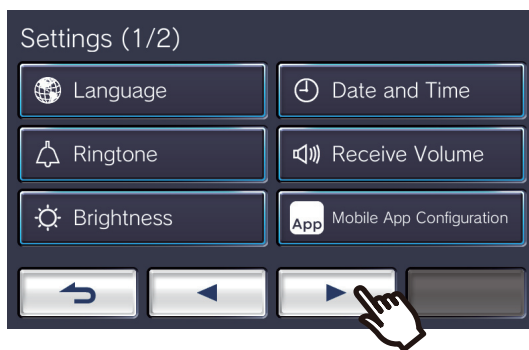

3. Tap [Station Information]



4. Tap 



5. Tap the upper right of the screen 5 times

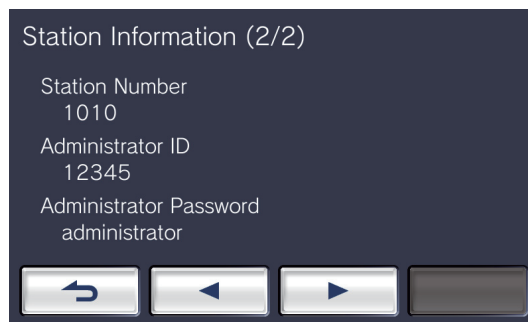
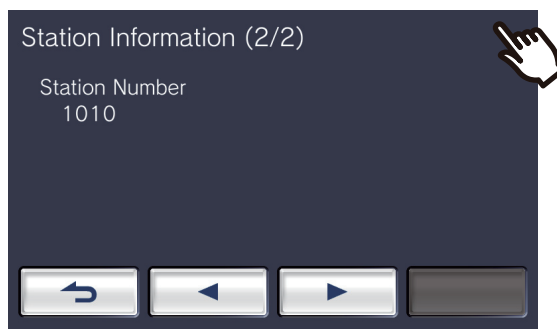



<https://www.aiphone.net/>

AIPHONE CO., LTD., NAGOYA, JAPAN

Issue Date: Nov. 2021 © 1121 RQ 64198